



This is a digital copy of a book that was preserved for generations on library shelves before it was carefully scanned by Google as part of a project to make the world's books discoverable online.

It has survived long enough for the copyright to expire and the book to enter the public domain. A public domain book is one that was never subject to copyright or whose legal copyright term has expired. Whether a book is in the public domain may vary country to country. Public domain books are our gateways to the past, representing a wealth of history, culture and knowledge that's often difficult to discover.

Marks, notations and other marginalia present in the original volume will appear in this file - a reminder of this book's long journey from the publisher to a library and finally to you.

Usage guidelines

Google is proud to partner with libraries to digitize public domain materials and make them widely accessible. Public domain books belong to the public and we are merely their custodians. Nevertheless, this work is expensive, so in order to keep providing this resource, we have taken steps to prevent abuse by commercial parties, including placing technical restrictions on automated querying.

We also ask that you:

- + *Make non-commercial use of the files* We designed Google Book Search for use by individuals, and we request that you use these files for personal, non-commercial purposes.
- + *Refrain from automated querying* Do not send automated queries of any sort to Google's system: If you are conducting research on machine translation, optical character recognition or other areas where access to a large amount of text is helpful, please contact us. We encourage the use of public domain materials for these purposes and may be able to help.
- + *Maintain attribution* The Google "watermark" you see on each file is essential for informing people about this project and helping them find additional materials through Google Book Search. Please do not remove it.
- + *Keep it legal* Whatever your use, remember that you are responsible for ensuring that what you are doing is legal. Do not assume that just because we believe a book is in the public domain for users in the United States, that the work is also in the public domain for users in other countries. Whether a book is still in copyright varies from country to country, and we can't offer guidance on whether any specific use of any specific book is allowed. Please do not assume that a book's appearance in Google Book Search means it can be used in any manner anywhere in the world. Copyright infringement liability can be quite severe.

About Google Book Search

Google's mission is to organize the world's information and to make it universally accessible and useful. Google Book Search helps readers discover the world's books while helping authors and publishers reach new audiences. You can search through the full text of this book on the web at <http://books.google.com/>



Class TL 272

Book F7

Copyright N^o 1918

COPYRIGHT DEPOSIT

CLASSROOM LECTURE NOTES

AUTOMOTIVE STARTING, LIGHTING AND IGNITION

WITH DIAGRAMS

BY
R. C. FRYER

*Chief Instructor, Starting, Lighting, and Ignition Division, School for Auto
Mechanics, War Education Department, University of Cincinnati,
Associate Member, Society of Automotive Engineers.*

*Formerly, Chief Electrical Instructor, Michigan State Auto School.
Author, The Automobile Electrician's Key (1917)*

SECOND EDITION

NEW YORK
JOHN WILEY & SONS, Inc.
LONDON: CHAPMAN & HALL, LIMITED

1918

TL272
F7
1918

COPYRIGHT, 1918
BY
R. C. FRYER

K6-2202!

NOV 20 1918

PRESS OF
BRAUNWORTH & CO.
BOOK MANUFACTURERS
BROOKLYN, N. Y.

©CLA506649

no 1

- 1 Box pith balls.
- 1 Stand with suspended pith balls.
- 1 Gold-leaf electroscope.*
- 1 Electrophorous.
- 1 Brass-plate condenser with glass.
- 1 Helmholtz or Wimshurst static machine.
- 1 Leyden jar.
- 1 Large classroom galvanometer.
- 1 Experimental primary battery (copper and zinc).
- 2 Lead strips to fit above cell or cup.
- 1 Generator (6 V. preferable—hand driven).
- 1 Set positive and negative battery plates with separators and cell.
- 1 Cut-open dry cell (see National Carbon Co.).
- 1 No. 6 Columbia dry cell.
- 1 Ruhmkorf spark coil ($\frac{1}{2}$ to $\frac{3}{4}$ or 1 inch).
- 1 6 V. storage battery, well charged.
- 1 Double contact, 6 to 8 V., 18 c.p. bulb.
- 1 Double contact, 6 to 8 V., 2 c.p. bulb.
- 1 Single contact, 6 to 8 V., 18 c.p. bulb.
- 1 Single contact, 6 to 8 V., 2 c.p. bulb.
- 2 Double contact, bayonet type sockets.
- 2 Single contact, bayonet type sockets.

Assortment of magneto armatures, generator armatures, starting motor armatures, field frame or two, loose series coils, loose shunt coils, magneto parts, etc.

*Catalog No. P3160, Eberbach & Son Company's Catalog, Ann Arbor, Michigan, may be substituted. Braun Electrometer.

indication of magnetism may remain. This slight indication remaining is termed "residual" magnetism.

The fact that iron does retain residual magnetism, even when the iron is very soft, has in part given ground for our most accepted explanation of magnetic energy. This explanation is called the "molecular theory of magnetism."

The molecular theory of magnetism supposes all material to be made up of infinitesimally small divisions of matter called molecules. In a piece of iron each of these little molecules is supposed to possess magnetic energy. In its natural state the molecules composing a piece of iron may lie in more or less of a criss-cross or "jumbled up" position, but when the iron is brought near a magnet the influence of the magnet causes these little molecules in the piece of iron to rearrange themselves in the iron and to lie parallel with one another in such a way that the magnetic energy possessed by each individual molecule is added to that of its neighbors and by the collective strength of all the molecules the piece of iron becomes a magnet and is said to be magnetized.

This theory is very nicely borne out by the fact that soft iron becomes magnetized very readily. Supposedly because of its being soft, its molecules can readily rearrange themselves when brought near outside magnetic influence. Likewise, soft iron when taken away from its outside magnetic influence very readily loses its magnetic effect, as because of its softness, the molecules composing it do not tenaciously retain their magnetized position.

A hardened steel bar is less easily influenced and less quickly magnetized than a soft iron bar for the reason that the steel, being in a hardened or compact condition, does not permit of quick re-arrangement of its molecules. Likewise, when a piece of hard steel is well magnetized this same fact also prevents the molecules from losing their magnetic arrangement readily, and the result is that the hard steel

retains its magnetic properties indefinitely and is then termed a permanent magnet.

We are going to find in our automobile electrical work that we shall require a piece of iron to become magnetized and to lose its magnetism as often as 9000 times per minute. We could not expect to accomplish this by the use of a piece of hard steel.

In other instances in our automobile work, it will be desired to have a magnet retain its strength indefinitely, and in this case, of course, we can not use soft iron. Therefore, while not essential, it is well for us to understand the underlying theory of magnetism, for we will then be able to know thoroughly the action of magnets under different conditions and will be able to reason clearly the causes of trouble which we will find in many pieces of electrical apparatus which make use of magnetism on the motor car.

The following are the rules and definitions governing magnetism and the magnetic circuit, which we will find it most necessary to memorize fully and more thoroughly understand:

The ends or extremities of a magnet from which the magnetic energy seems to radiate are called the "Poles of the Magnet." To demonstrate, take a plain bar magnet, lay same on piece of glass and sprinkle iron filings uniformly its full length, covering it entirely; grasp magnet near center (equator) and lift same from glass—filings will adhere in clusters at ends or poles of magnet. Note the direction in which the filings seem to point from poles, showing direction of magnetic lines of force.

The total number of magnetic lines of force from the poles of a magnet are termed the "Flux of the Magnet." Take a strongly magnetized horse-shoe magnet, dip the poles in a box of iron filings, grasp the pole of the magnet in the hand, grouping the iron filings closely together and explain that

the flux of the magnet is the entire group of lines of force passing through its field.

The path of the flux (total number of lines of force) is as follows: Through the steel of the magnet from the south (minus) or negative pole of the magnet to the north (positive) or plus pole, leaving the north pole and passing through the intervening space, entering again at the south pole. Lay a pane of glass over a horse-shoe magnet, the north pole of which has been marked with a piece of chalk. Use a large magnet from a magneto. Sprinkle iron filings lightly over the glass and tap the glass. Iron filings will arrange themselves as the lines of force flow. Make a large diagram, on blackboard, of horse-shoe magnet and indicate by arrows the passage of magnetic flux through field from north to south pole; and through magnet from south to north pole. Explain at this time how to place two magnets (compound) together in the proper way. Explain, also, necessity of placing piece of soft iron across poles of a horse-shoe magnet to retain strength; also, explain how two horse-shoe magnets may be laid together, north and south poles adjacent, forming a closed magnetic circuit which will help retain their magnetic energy.

The space surrounding the magnet, through which the magnetic lines of force pass is termed the "Field of the Magnet." By aid of foregoing diagram and the glass over the horse-shoe magnet, show that space which is passed through by magnetic lines of force, and explain the magnetic field.

A salient pole is one of the main poles of the magnet. A consequent pole is a pole formed at some intermediate point by the breaking away of a portion of the lines of force from the main magnetic circuit. Refer again to the glass with iron filings over the horse-shoe magnet. Note that at bend in horse-shoe magnet some lines of force leave the main

magnetic circuit, forming at these points consequent poles. Call attention to the fact that the main poles, or the extremities of the magnet, are the salient poles.

The north, or positive pole, is known as the "Plus Pole." The south, or negative pole of a magnet is known as the "Minus Pole." Every magnet must have at least two poles.

Perhaps the most important law of magnetism is the following: Poles of a like sign, that is, two plus poles or two minus poles, repel one another; while poles of an unlike sign, that is, a plus and a minus, attract one another. Take two horse-shoe magnets from magneto, alike in size, dip both poles of each in box of iron filings. Hold one magnet in each hand, placing their poles opposite one another. Note that when unlike poles are held together the filings are not attracted to one another, but violently repelled.

ELECTRICITY

Electricity while a more or less familiar term to us, is a form of energy very hard to define. Much as we have learned about it, the information which we possess is yet in the nature of facts which govern its action under different circumstances.

We know how to "produce," or cause electricity to become active; we can foresee what its action will be under many different circumstances; we can measure it and know the work it will perform, and we know of its very close association with magnetism; yet, just what it is is a very deep question and, as yet, may be considered as a matter of conjecture. Electricity is distributed throughout all nature, but we hardly give credence to this fact for the reason that it is at rest, or in a latent state. Electricity manifests itself to our senses in many different ways, among the most important of which are light, heat, and power.

Electricity while in a static condition, or at rest, exhibits

no energy. We may compare it with the flow of water. We will all readily understand that a pool of stagnant water produces no power, but that the power obtained from water is obtained through the flow or motion of the water. We may say the same of electricity. In order that it may work for us it must be first set in motion; must be flowing from one place to another.

Pick up vulcanite rod and pass hands over same to be sure no charge of electricity has accumulated on rod. Hold this rod toward stand with suspended pith balls and no effect will be noticed. Explain that the rod has or contains electrical density to a certain point, but that it is in a static or inactive state and, therefore, no influence is noted. Now, with cat's fur, rub the vulcanite rod briskly and, holding it by one end, place the opposite end near suspended pith balls. Balls will be attracted to the rod and will remain in contact with the rod until they become charged to a like density compared with the rod, when they will be repelled by the rod. Note that the two pith balls now repel one another as they have received from the rod an accumulation of electrical energy. This electrical energy was not manifest until it flowed from the rod to the balls. Use the Wimshurst Static Machine and hold these two pith balls suspended in the gap between the discharge points of the machine. Operate the machine and note that the suspended balls will rapidly travel back and forth, conveying the accumulated positive charge from the positive side to the negative side of the machine. Suspend one brass plate about 3 inches above a similar plate, insulating these two plates from one another and connecting one plate to the positive side of the Wimshurst machine and the other plate to the negative side of the Wimshurst machine and place several light pith balls on lower plate. The pith balls will travel rapidly up and down, conveying the positive charge

from the positive brass plate to the negative brass plate. In this experiment, the electrical energy in traveling from the positive brass plate to the negative brass plate has been used to carry these light pith balls back and forth.

Just as there are many ways in which we may cause water to flow, there are also many ways in which we may cause electricity to flow. And there are many things through which a current of electricity may flow.

A common way to cause water to flow is by storing it in a reservoir and piping it from this reservoir to its destination. It has, of course, occurred to you that the water must accumulate or be placed in the reservoir before it can be drawn out. This will, of course, require energy. Comparatively speaking, electricity may be placed, as it were, in a reservoir; that is, certain bodies or objects may be caused in different ways to accumulate a large quantity of electricity in the form of electrical energy, and this electrical energy may be led away from these bodies by means of our "pipe line," which we will call our "conductor."

A little later in our course we shall compare the production of the flow of electrical energy to the pumping of water through a pipe line.

After performing the foregoing experiments, which will, perhaps, make the foregoing statements a little more clear to us, try to understand and remember the following rules:

When one body, which is compared to another body, is found to possess a greater electrical density than the other body, the one body is said to be in a positive or plus "state of charge," compared to the other body.

If these two bodies be brought closely together or connected by a conductor, the electrical energy will tend to flow from the positively charged body to the lesser or negatively charged body and this flow will continue until each of these bodies are charged to a like density.

By comparison with other bodies containing a greater or less electrical density, these two bodies may then be said to both be "positive" or both be "negative."

Electricity in passing from one body to another is termed a "current" of electricity.

Electricity may be compared, also, with magnetism because of the fact that electrified objects exhibit the power of attraction and repulsion much as magnets do.

The rule governing electrical attraction and repulsion is very similar to the rule governing magnetic attraction and repulsion; but let us caution you while making this comparison to keep those definitions of electricity and magnetism distinctly separate in your mind.

Remember that the positive pole of a magnet does not refer in any way to a body which is "positively charged."

The electrical law of attraction and repulsion is as follows: Bodies charged to a like density; that is, two positively charged bodies or two negatively charged bodies will repel one another. Two bodies charged to an unlike density; that is, a positively charged body and a negatively charged body, attract one another.

This law is going to form the basis upon which the production of all light, heat and power from electricity which we shall employ upon the automobile, is based. A thorough understanding is essential.

CONDENSERS

The condenser is the first piece of electrical apparatus used on the motor car, the operation of which we shall study.

It is perhaps the simplest piece of electrical apparatus used on a car; but while being a piece of simply constructed apparatus, remember that it is of prime importance to the proper operation of the ignition system.

We have seen before that two bodies, one of which is positively and one of which is negatively charged, attract one another. Upon this principle depends the operation of the condenser. For our demonstration we will use two large brass plates, separated by a piece of glass.

We shall use the Wimshurst electrical machine, by which we may produce a highly charged condition positively of one brass plate, the other being negative. Observe that the attraction of the positive for the negative becomes so great that the electricity, which finds it impossible, or nearly so, to pass through glass, will finally jump around or arc over the glass.

Disconnecting the brass plates from the machine we will leave them in a charged condition, and using a conductor leading from one plate to the other we will allow the charge between these plates to equalize, or neutralize, observing the "spark" that occurs upon the passage of the electric current.

Now, the amount of storage capacity that these brass plates possess is going to depend upon several things and will hereafter be known to us as the "capacity" of the condenser.

This capacity of the condenser depends upon:

- (a) The area of the conductors.
- (b) The distance between the conductors.
- (c) The nature of the non-conductor, which is called the di-electric.

In honor of the French scientist, Faraday, the unit of measurement of condenser capacity has been termed the "farad." While we will not take up the exact definition of the farad, let us say, while it is not such a great capacity, it is a greater quantity than we find generally necessary in the practical use of condensers in electrical work. Therefore, the farad has been sub-divided into one million parts

and this unit, being one-millionth of a farad, is called the "microfarad" and is abbreviated "m.f."

The capacity of condensers in general use in ignition systems on motor cars is about as follows: For high-tension magneto ignition, one-tenth to two-tenths of a microfarad, while the capacity of condensers used for battery ignition systems may generally be said to vary from two-tenths to three-tenths of a microfarad.

While we will have in our repair shops very little chance to measure accurately the exact capacity of condensers, if you will remember these capacities, we will explain in our lectures upon ignition, why and how a condenser of high, or low, capacity will seriously affect ignition.

In usual practice, condensers are constructed of sheets of tinfoil used as conductors, interleaved with sheets of paper or mica, which serve as the di-electric.

A representative condenser used with the Delco ignition system and having a capacity of two-tenths to twenty-eight hundredths of a microfarad, is constructed of three sheets of paraffine-impregnated paper and two sheets of tinfoil, interleaved as the conductors. The sheets of paper are approximately $1\frac{3}{4}$ inches in width and 13 feet in length. The tinfoil is slightly narrower and of about the same length.

Trouble has been experienced in this and other condensers due to the fact that gasoline vapor which is often present under the hood of the car sometimes dissolves the paraffine of the paper, destroying its insulating qualities and thus causing a change in the capacity of the condenser.

Means of testing condensers and their exact action in the ignition circuit will be fully explained under Ignition.

Please remember those things upon which the capacity of a condenser depends.

DRY CELLS

We have been told in previous lectures that electrical energy may be excited in different ways. We have described a few laboratory ways. A few years ago the dry cell was a very popular means of producing electrical energy in comparatively small quantities with very little pressure or electromotive force (E.M.F.) (electrical moving force). The dry cell as usually constructed consists of a zinc cup. This zinc cup contains a porous substance known as manganese dioxide. This manganese dioxide has somewhat the appearance of a carbon and is granular. A carbon rod which projects from the top of a dry cell is packed in this manganese dioxide in such a way that the carbon does not come in contact with the zinc. This manganese dioxide is then saturated with a solution of sal ammoniac, after which the top of the zinc cup is filled with a sealing compound, which is an insulator or non-conductor. To prevent actual contact between the manganese dioxide and the zinc cup a layer of heavy blotting paper lines the zinc cup. Upon connecting a conductor from the carbon rod to the zinc cup, a current of electricity flows from the cell.

This current of electricity is produced by chemical action and may be termed galvanic electricity. Small amounts of current may be drawn intermittently from the cell without destroying the recuperative properties, but during the process of giving off current the zinc cup gradually wastes away and finally the cell becomes inactive. There is no practical way of recharging worn-out dry cells. Consequently, its use as a producer of current is becoming obsolete.

The path of the current from a dry cell is as follows: From the zinc, through the saturated manganese dioxide to the carbon rod; from the carbon rod through the wire or conductor of the circuit back to the zinc cup. The pressure

or as has been explained in your lecture, the E.M.F. or voltage of a dry cell, is approximately $1\frac{1}{2}$ volts.

We are all more or less familiar with dry cells and can get a very good comparative idea of the value of the volt (which is the unit of electrical pressure) by comparing and remembering that the pressure of the dry cell is $1\frac{1}{2}$ volts. Remember that in your circuit the carbon rod is the positive terminal of the dry cell and the terminal which is affixed to the zinc cup forms your negative terminal.

Remember that with dry cells connected in series the voltage of the series is equal to the voltage of one cell times the number of cells connected in series.

Remember also that with dry cells connected in parallel (or multiple) the amperage is equal to the amperage of one cell times the number of cells connected in parallel, while the voltage remains equal to the voltage of one cell only.

The ampere is the unit of measurement of the rate of flow of electrical energy, and may be compared to the number of gallons of water per a given time flowing through a pipe. A dry cell may furnish, for a short time only, as high as 28 to 30 amperes of current, but its normal discharge rate should never be expected to exceed from 3 to 5 amperes.

ELECTRICAL MEASUREMENTS

The volt is the unit of measurement of electrical pressure or E.M.F.; and the number of volts pressure of a circuit is frequently referred to as the voltage of the circuit. It is to be remembered that the voltage is the pressure, or is the cause of movement of electrical energy.

The ampere is the unit of measurement of rate of flow. It may be compared to the rate of flow of water through a pipe which is spoken of as so many gallons per minute or so many cubic feet or cubic inches per minute.

Resistance is that property of a conductor which tends

to hold back, retard or resist the flow of current. All conductors offer some resistance to the passage of electrical current. Some conductors offer a very great resistance; so great, in fact, that no noticeable amount of current can flow through them. These conductors are termed insulators or non-conductors.

Among the conductors having the lowest resistance are silver, copper, and alloys and practically all metals in varying degrees of resistance.

Conductors are heated by the passage of electrical current, noticeably so when the current is heavier than the size of the conductor is sufficient to carry. Usually, with an increase of heat the conductor also increases in resistance. While this is true in most instances, there are exceptions—one of the most notable of which is carbon, the resistance of which decreases with an increase of temperature.

The unit of measurement of resistance is called the ohm. Based upon this unit, the relations of voltage, amperage, and resistance are stated as follows: **A pressure of one volt will force a current of one ampere through one ohm of resistance.** This is commonly called Ohm's Law. Stated in terms of everyday use, it has been said that the volt shoves the ampere through the ohm.

Continuing this speech farther, we might say that it will be useful to remember that it is the volt which does the shoving; the ampere which is being shoved; and the ohm is that through which the ampere is being shoved.

The different terms and abbreviations by which we will know the pressure of the circuit are V., Volt (Voltage), E.M.F., or E; for rate of flow, Amp., Ampere (Amperage), or I; for resistance, Ohm, or R. Stated in the form of a formula in the simplest way, we will use the following:

$$\frac{E}{I \times R} = 1$$

E designating voltage, I designating amperage, and R designating resistance.

When any two of these three are given, we may easily find the other one. A practical way of remembering this is to place your finger over the letter designating the value you wish to find; for example, we may assume we have the voltage and amperage of a circuit given to find the resistance, place your finger over R and this will leave you E above the line and below the line, indicating that the value of volts is to be divided by the value of amperes, the quotient obtained being the resistance, or R . Supposing we have the resistance and amperage given to find the value of the voltage, we will place our finger over E . This leaves below the line $I \times R$, indicating that the value of amperage is to be multiplied by the value of resistance (Ohms), the product being the value of the voltage, or E .

Any circuit with a given voltage and amperage flow will expend a certain amount of energy. The practical unit for the measurement of electrical energy is termed the watt. In direct-current circuits, such as are commonly used on the motor car, the number of watts of a circuit is obtained by multiplying the voltage by the amperage, the result being watts.

We are all, doubtless, familiar with the term "horse-power." Power which is sufficient to lift 33,000 pounds to a height of 1 foot in one minute is termed 1 horse-power. Seven hundred and forty-six watts of electrical energy are sufficient to perform this work, therefore, one electrical horse-power equals 746 watts of energy.

The sale of electrical energy is based upon a measurement of 1000 watts, called the kilo-watt. A thousand watts used for one hour are termed a kilo-watt hour.

The above definitions will cover practically all the units of electrical measurements which you will find necessary

in Starting, Lighting, and Ignition, although these units form only a portion of those used by an electrical engineer.

ELECTRO-MAGNETISM

Any conductor through which a current of electricity flows is surrounded by magnetic lines of force. Viewed from the end of the conductor at which the current enters, these lines of force always whirl about the conductor in the direction in which the hands of a clock turn, or in a right-hand direction. When a conductor carrying an electrical current is wound about a core of iron, the core of iron becomes magnetized.

The direction of the magnetic flux, or the polarity of the core, will depend upon the direction in which the current in the winding flows and the direction in which the wire is wound.

The Rule of Thumb.—Hold a piece of iron in your right hand. Begin at the end next your little finger and wind a layer of wire about the core in the direction in which your fingers point. Send a current through this wire from the end next your little finger and the core will become magnetized with your thumb pointing toward the North Pole.

Up to the point of saturation, the strength of an electro-magnet depends upon the number of amperes flowing through the winding, and the number of turns in the wire. In other words, up to the point of saturation, the strength of an electro-magnet depends on the number of ampere turns.

One ampere of current flowing through one turn of wire is one ampere turn; or one ampere through two turns of wire is two ampere turns, etc.

Therefore, to find the number of ampere turns, multiply the amperes by the number of turns of wire in the coil—the result will be the number of ampere turns of the coil.

Caution. Do not confuse the positive pole of your source of current with the north pole of an electro-magnet. Remember that the pole of the electro-magnet depends upon the direction of your current and the direction in which the wire is wound.

INDUCTION

We have found that every conductor carrying an electric current is accompanied by magnetic lines of force. Likewise, when a conductor is moved through a magnetic field, or a magnetic field is moved about a conductor, and electric voltage will be induced in the conductor and this current will be termed an "induced" current.

A movement of a magnetic flux about a conductor does not necessarily mean that the magnet itself must be moved. Any movement of the magnet causing a movement of the field, or any movement of the magnetic flux itself about a conductor, or any movement of the conductor through the magnetic flux or field will set up voltage in the conductor.

The strength (voltage) of the current set up in the conductor (this induced voltage) depends upon

- (a) The strength of the magnetic flux.
- (b) The speed of the movement taking place between the flux and the conductor.
- (c) The number of turns in the conductor.

Any conductor which cuts lines of force at the rate of one hundred million (100,000,000) in one second's time will have produced in it an E.M.F. of one volt. Two conductors connected (electrically) in series, moving in a magnetic field and cutting the same lines of force would, to produce one volt, therefore, have only to cut half as many lines of force.

In practice, it is common to arrange a number of conductors in series in order that we may reduce the speed of

their movement, as well as reduce the number of lines of force necessary in the magnetic field.

These rules governing induced currents will govern the action of induction coils, magnetos, and generators.

Probably the clearest way in which induction can be demonstrated would be to procure a core of soft iron wires about which, and insulated from which, is wound a coil of insulated wire which may be connected across a 110-V. alternating current, such as is used for lighting purposes in most cities. The rapid reversal of alternating current will cause a rapid reversal of the magnetic flux through the soft iron core. Take an ordinary field coil from a 6-volt generator and connect across its ends a 3-volt, 2-c.p. bulb. Hold this coil directly over one end of the core and the rapid reversal of the magnetic flux from the core, striking the field coil, will induce in this field coil a voltage sufficient to cause the filament of the bulb to glow. Numerous experiments with coils of wire containing different numbers of turns can be made which will convey to the student, forcibly and clearly, the idea of induction.

By using the separably mounted, concentric primary, secondary and core, and connecting the secondary to the classroom galvanometer, open and close the circuit from the battery through the primary of this coil. Call attention to the fact that when the primary circuit is closed the induced current flows in the secondary in one direction, and that when the primary circuit is open the galvanometer shows that an induced current flows in an opposite direction from the secondary.

The voltage produced in the secondary when the primary circuit is broken will be noted to be higher than the voltage produced when the primary circuit is closed.

Now, if you will procure a condenser from an ordinary battery ignition system and connect one terminal of the con-

denser to one side of the point where the primary circuit is broken and the opposite side of the condenser to the opposite side of the point where the primary circuit is broken, you will note that the deflection of the galvanometer when the primary circuit is broken is very much greater than before the condenser was connected. The action of the condenser is explained in the following under "The Induction Coil."

THE INDUCTION COIL

Definition. The induction coil is an arrangement of coils whereby a current of electricity in flowing through one coil, called the "primary winding," produces a magnetic flux in a soft iron core. This magnetic flux is broken up by a second winding called the "secondary winding," and in so doing produces an induced current or voltage in this secondary coil.

This secondary winding has a great many turns of very fine wire and the magnetic flux from the primary coil, in striking through this secondary winding, is broken up by thousands of turns in the secondary coil.

As there are so many turns in this secondary winding, the voltage produced therein reaches such a high point that it will jump a gap, causing a spark to occur, which we use to ignite a charge of gas.

A secondary voltage is created both upon the opening and closing of the primary circuit, but as the rapidity with which the magnetic flux from the primary core dies away, or moves from around the secondary winding, is much greater when the primary circuit opens and the magnetic flux dies, we depend upon the secondary current, which is produced at the time the contact points of the primary circuit open, to fire our charge of gas in the cylinder.

At the time the primary circuit is broken, the dying out

of the magnetic flux also produces in the primary winding an induced voltage which we term a "self-induced current," or "self-induction." This self-induced current which is set up at the opening of the timer points tends to follow the primary circuit in the same direction as the battery current flowed which magnetized the core. This causes excessive sparking at the contact or timer points.

We connect our condenser across or in parallel with our timer or contact points and upon the opening of these timer points this self-induced surge of voltage from the primary current will rush into and charge the condenser. Arcing and sparking at the contact points is thus almost eliminated.

But the further and more important function of the condenser is this: Before the contact points close again this surge of current which charged the condenser is kicked by the condenser back through the entire primary circuit, equalizing the charge between the two sides of the condenser and in so doing flowing through the primary circuit in the reverse direction; it aids greatly in acting against and quickly removing the magnetic flux from the primary core which was set up by the battery current at the time the contact points closed.

This reverse action of the condenser is of great importance in quickly demagnetizing the core of the coil and producing a sudden magnetic change of flux through the secondary winding, which causes the secondary voltage to rise quickly to a very high point.

It must be remembered that this action which has been outlined takes place very rapidly, actually occurring between the opening and closing of the contact points in the ignition system.

INDUCTION, INDUCTION COILS, AND BATTERY IGNITION

Definition. Induction is nothing more nor less than the production of electrical voltage by the movement of a conductor across a magnetic field, or by the movement of magnetic flux about a conductor.

While it will not be necessary to use the following rule often in ignition work, it will be of great value to us in magneto and generator work. This rule will help you to determine the direction in which an induced current will flow in a conductor when you know the direction in which the conductor cuts the lines of force and the direction of the magnetic flux. **Rule.** Hold the thumb and first and second fingers of the right hand in such a way that each shall be perpendicular to the direction of the other two. Turn the hand so that the thumb shall point in the direction of the motion of the conductor, while the index or first finger points in the direction in which the magnetic flux flows, and the second finger will show you the direction in which the induced current will flow through the conductor.

Battery ignition systems may be divided into three general classes:

- (a) Known as the Closed Circuit Ignition System.
- (b) Known as the Open Circuit Ignition System.
- (c) Known as the Vibrating Ignition System.

The Closed Circuit Ignition System is the system in which the contact points of the breaker mechanism remain normally in contact until separated by the action of the cam which operates them. With the closed circuit system, the length of time which the contact points remain closed varies with the speed of the engine. They remain closed longer at low speeds and a shorter length of time at high speeds. With the engine not in operation the points of a closed circuit

system remain closed unless the cam stops in such a position as to hold them open.

This makes necessary the use of some protective device in the ignition primary, and a resistance is usually connected in series with the primary circuit. When the engine is running slowly, this resistance unit is heated up by the passage of current, its resistance increases with its temperature, and it holds back the flow of the primary current, limiting its value to an amount which will not produce excessive sparking at the contact points and which will not heat the primary winding of the coil. At higher engine speeds the contact points remain closed a shorter length of time, the resistance unit does not heat so readily, and its resistance does not increase to a point where it retards the flow of the current noticeably; therefore enough current to produce a good magnetic flux in the core is allowed to flow through the primary at high engine speeds.

An exception to the use of the resistance unit is found in a Connecticut Ignition System. This system uses a thermostatic circuit breaker, which protects the primary circuit should the ignition be left "on" when the engine is not running and should the contact points then be closed. In most other ignition systems of the closed types, should the engine stand with the contact points closed and the ignition "on" the resistance unit will become very hot and by increasing in resistance will also, to a certain extent, protect the primary circuit.

An Open Type Battery Circuit, an example of which is the Atwater-Kent System (Types "K" or "H") is so constructed that the contact points of the breaker mechanism remain open normally, being closed by the action of the cam. This system, of course, requires no resistance unit nor protective device. On the Atwater-Kent (Types "K" or "H" Unisparker) the period of contact remains the same

at both high and low speeds and is of much shorter duration than the period of contact of closed-ignition circuits.

The Vibrating Battery Ignition Type is the system which uses a vibrator in connection with a coil, giving a shower of sparks continually as long as the timer points remain in contact.

Its chief example at the present time is that system used on the Ford car.

In both closed and open non-vibrating battery-ignition systems, the spark occurs practically with the opening of the contact points. With the vibrating battery-type ignition system the spark practically occurs with the closing of the timer points.

In most closed circuit battery ignition systems, the opening of the contact points varies from .015 to .020 of an inch. One notable exception to this distance in opening is the Atwater-Kent Type CC System, the points of which open from .006 to .009 of an inch.

In the open-circuit battery-ignition systems the usual opening is from .008 to .010 of an inch.

IGNITION AND SPARK ADVANCE

The many peculiar factors determining the conditions which govern the actual burning and combustion of gas in the gasoline engine make necessary a change in the time of the occurrence of the spark in the combustion chamber.

Considered from the standpoint of economy and smooth operation, it is found necessary that the spark occur earlier at some times than at others.

This causing of the spark to occur earlier may be accomplished in three ways: namely, by hand, automatically, and semi-automatically. There are, also, engines built in which some certain point is chosen which is most economical con-

sidering all the varied engine speeds, and the spark is set to occur regularly at this time. This is known as set-spark ignition. The three instances just mentioned, in which the spark may be caused to vary in time, are termed advance and retard systems.

The ideal condition is to have the combustion of the gas completed at the point of highest compression; that is, when the piston is passing upper dead-center of the compression stroke.

Caution. Do not get the idea when speaking of spark advance that the actual completed combustion or explosion of the gas takes place ahead of upper dead-center, as this should not be.

A certain length of time elapses between the actual occurrence of the spark and the actual or completed combustion of the gas. This time which elapses, while it may be considered as more or less constant, does in reality vary with the variation in the mixture of the gas.

It will also vary in different makes of engines with the compression and also depending upon the point in the compression chamber at which the spark takes place, also on the same engine with speed, and with load because the mixture changes with load.

THE TIMING OF THE SPARK

The spark on all four-stroke cycle motors (except those equipped with ignition systems having a set spark and no advance mechanism) should be set and adjusted so that the spark will take place just as the piston has passed top-center on the explosion stroke when the spark lever is fully retarded usually from 3° to 7° , or from $\frac{1}{2}$ inch to 1 inch past the dead-center mark on the flywheel.

When a set spark is used (in which case there is no manual

advance lever) the spark is set to take place about 15° before the dead-center mark on the flywheel. In other words, it is advanced 15° . Battery ignition is never set this way.

To install a magneto-ignition system so as to fire the proper cylinder at the proper time, proceed as follows: on either a four- or a six-cylinder motor, crank the motor slowly by hand and, at the same time, watch the exhaust valve on the rear cylinder. When this valve has just seated, the front piston will be about at the firing point. The distributor should then be set so that the high-tension distributor arm or rotor is in contact with the segment from which the secondary wire leads to spark plug No. 1.

If the exhaust valve on the third (or fifth) cylinder operates (or closes) next in succession, the No. 2 cylinder should fire next, and so on, as the pistons in all standard makes of motors work together and fire alternately as follows:

| | |
|---------------|----------------|
| Six Cylinder. | Four Cylinder. |
| Nos. 1 and 6 | Nos. 1 and 4 |
| Nos. 2 and 5 | Nos. 2 and 3 |
| Nos. 3 and 4 | |

In summary, we will then say that because of the fact that a certain amount of time elapses between the actual occurrence of the spark and the full combustion of the gas, it is necessary that the spark be advanced far enough to cause the combustion to take place at the point of highest compression to obtain efficient and smooth operation.

SOLDERING

Soldering will be one of the many important things which it will be necessary for the automobile electrician to know how to do well. All terminals of wires should be soldered securely to the wire, all splices of wires should be mechanically and electrically secure without solder, and then

soldered and taped; all splices such as field coils of generators should be soldered.

Loose connections are the cause of a great many troubles in starting, lighting, and ignition systems.

To solder well the following things are necessary:

1. A good, clean, blue flame in which to heat the solder bit.
2. A well-cleaned, well-tinned soldering bit.
3. A good non-corrosive flux.
4. Care that bit and work are properly heated so that the solder will "sweat" to the work.

For the flame a good gasoline torch may be used. If used, proceed as follows to light the torch: Fill the cup under the burner well full of gasoline, first seeing that the tank is pumped to a good pressure. To fill the cup, open the valve and place hand over the burner; do not place the torch in a draught or in the wind; close valve and light the gasoline in the cup; allow the gasoline to burn almost entirely out of the cup and then open the valve—the burner should be hot enough to thoroughly vaporize the gas passing through it and the gas should ignite when the burner is hot enough. The flame should be steady, blue, and pointed. If the flame does not have enough pressure, pump more air into the tank.

For stationary work, such as bench work, a good gas soldering bit furnace is to be recommended. Do not expect to secure a well-heated, well-tinned bit if the flame is yellow, for the bit will be covered by soot.

To tin the bit, first take file and shape bit to a point; see that bit is bright over all the soldering surface; heat well in a clean flame, but do not burn bit or scale will form on same; rub soldering surface on large lump of sal ammoniac and form pit in sal ammoniac and hold solder against bit, allowing solder to form a pool in pit on sal ammoniac. Sal ammoniac will serve as flux and solder will tin the bit fully

over the soldering surface; remove bit from sal ammoniac; wipe off; clean with rag or waste; and retouch with solder while bit is yet hot.

For a flux we would recommend some good resinous compound for electrical work; not an acid flux, as acid will have corrosive effect upon copper wire. **No-korode** is recommended as a satisfactory flux. Prepare the work by removing all dirt or grease; and, if possible, after cleaning brightly, tin the surface or surfaces to be soldered before actually "sweating" the finished work. It is absolutely essential that the work to be soldered be cleaned. If soldering wires are used on the car, carefully tape each joint after soldering. It is good practice to use both a rubber compound and a friction tape in covering splices, but the rubber compound may be omitted upon the car as the system is of low voltage. We would not recommend soldered and taped joints in secondary wires. Use a continuous wire in this circuit if possible. In taping with friction tape, be sure that there is no oil or grease on tape, as this will prevent the tape adhering to the joint. In taping splices made in generators do not use friction tape, but use cotton or linen tape and lay it on carefully, after which paint it with orange shellac and allow to dry thoroughly. If needed for immediate service, the shellac can be quickly dried by applying a burning match to the completed joint and burning the alcohol from the shellac. The flame will first be blue from the alcohol and after the alcohol is burned out, will become yellow. Do not allow to burn after flame becomes yellow, but blow out immediately and the work is ready for use. Neatness in soldering and taping of joints is evidence of good workmanship.

MAGNETO CLASSIFICATION OUTLINE

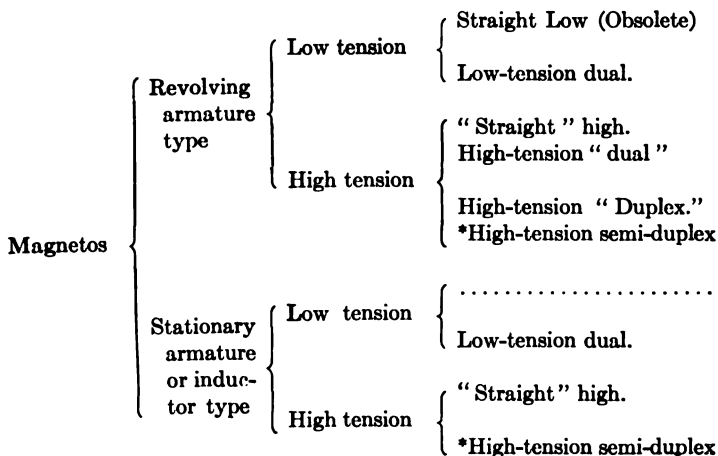

* Not standard.

DEFINITIONS REFERRING TO CLASSIFICATION OUTLINE

A magneto is a machine for the production of electrical energy by the movement of a conductor across a magnetic field, or by the movement of a magnetic field or flux about a conductor, that magnetic field being furnished from permanent magnets. Practically speaking, a magneto usually produces A.C. A.C. is a current which changes its direction periodically, first flowing in one direction and then in the opposite direction.

A cycle is two alternations. It begins at zero voltage, rises to a maximum in a positive direction, returns to zero; rises to a maximum in a negative direction and returns again to zero, having completed two alternations.

In a magneto, the armature is that portion of the machine in which the current is produced, be it stationary, or be it revolving.

Magnetos are divided into two general classes—revolving armature types and stationary armature or inductor types.

Revolving armature type magnetos are magnetos in which the current is produced by the movement of the armature through the magnetic flux.

Inductor-type magnetos are magnetos in which the current is produced in a stationary armature by the movement of the magnetic flux about this armature.

Both revolving-type and inductor-type magnetos may be divided into two classes—"high" tension and "low" tension magnetos.

A low-tension magneto producing and using a straight low-tension current, while it has been used in the old "make and break" ignition systems, is now obsolete, having been superseded by the low-tension dual magneto.

A low-tension dual magneto is a low-tension magneto which produces a current of low voltage which is stepped up by an outside coil after which it is distributed to the spark plugs. It also has an arrangement whereby a battery current may also be used through its interrupter points, stepped up by its coil and distributed to the spark plugs, thus giving this magneto the name of "dual."

A straight high-tension magneto is a magneto which produces, times, steps up and distributes its current to the spark plugs without the use of any outside coil or transformer.

A high-tension dual magneto is a high-tension magneto so arranged that a battery current may be used through its auxiliary set of timer points, stepped up by an outside coil and then distributed by the magneto to the spark plugs.

A high-tension duplex magneto is a high-tension magneto so arranged that a battery current may be used through its

interrupter points, stepped up by its own armature windings, and distributed by the magneto to the spark plugs.

Caution. The magnets of high-tension duplex magnetos must never be reversed when placed on the magneto, and the connection of the battery current to the magneto commutator must always be made in the proper direction.

A high-tension semi-duplex magneto is a magneto arranged as a duplex high-tension magneto without a commuting (changing) device. These are not often used and a semi-duplex is not considered good magneto construction.

The opening of the contact or interrupter points of low-tension magneto systems of the "dual" type is much wider than the regular ignition systems. These points usually open from .020 to .030 of an inch.

The opening of the contact or interrupter points of high-tension magnetos usually varies from .015 to .020 of an inch. Exception to this is the Eisemann high-tension magneto upon which the regular opening of the points is three-tenths of a millimeter (.3 mm.), or from .012 to .014 of an inch.

While the above is true in most cases in considering different types of magnetos, the opening each individual magneto interrupter points should be followed.

INTERNAL TIMING OF H OR SHUTTLE-TYPE MAGNETOS

Advance Breaker Mechanism. Turn armature by hand in direction it is to be driven on car with interrupter points just opening. Cheek of armature should have passed away from pole piece about one-sixteenth ($\frac{1}{16}$) of an inch. High-tension distributor arm should be fully under segment in distributor block.

To Check. Retard Breaker Box. Turn armature by hand in direction it is to be driven on car with points of interrupter just in act of opening. The cheek of armature should

have passed to about three-eighths ($\frac{3}{8}$)-inch distance from pole piece. At this time, the high-tension distributor arm should be on the leaving, or retard, side of the segment in the distributor block, or board, or head.

The above rule will apply to the internal timing of standard revolving armature-type magnetos which have standard pole pieces.

Internal timing of magnetos having special pole pieces or shoes, such as the Simms and Eisemann; and inductor type, such as the Dixie and Mea, will be taken up in detail in studying each of these different makes.

EXPLANATION OF INTERNAL AND EXTERNAL CIRCUITS OF EISEMANN MAGNETO AND D C R COIL

Magneto Position of Switch. Terminal *H* of coil closed to *HM* on coil.

Ma on coil now disconnected from the ground post *M*.

Primary circuit of the battery ignition side now open from positive terminal on coil to primary segment.

High-tension current from secondary of magneto armature flows to collector ring, to terminal *HM*; through segment to terminal *H*, to center of distributor head, to high-tension distributor arm, to spark plug of firing cylinder, to frame or ground, to ground of primary winding on armature, and through primary to secondary armature winding. Primary armature circuit is at this time through interrupter points (those which revolve) to ground and returns to opposite (grounded) side of primary on armature.

Off Position of Switch. *MA* terminal on coil connected through segment of switch to *M* or ground terminal, thus grounding the primary armature circuit of the magneto and producing no spark from magneto. In actual practice on the Pierce-Arrow truck, there is no ground lead on post *M*,

the ground being secured through the mounting of the coil unit, and through the metal dash.

With the switch in this (off) position, the battery circuit is yet open between the positive battery terminal on coil and the segment on the switch to which the primary winding for the battery circuit is attached. Thus both magneto and battery circuits are put out of operation with switch in "off" position.

Switch on Battery Position. Terminal *MA* remains yet in contact with ground segment in switch, thus magneto armature produces no high-tension current.

Primary battery circuit is now as follows: From battery to positive terminal of switch, and from positive terminal into segment of switch to which primary of coil is connected, through primary of coil to interrupter ratchet points, and through these points to switch segment which is not in contact with terminal *R*, from terminal *R* to auxiliary breaker points of magneto; to ground and back to grounded side of storage battery.

A condenser, which is assembled in the coil unit, acts for both the auxiliary or battery points and the compression or ratchet points in the coil. This condenser can be tested in the regular way by disconnecting coil, opening ratchet points (see that ratchet arm makes contact with neither upper nor lower of its contact points) and testing from *M* terminal to the arm itself, or to the stud on which it is mounted.

With the switch in battery position, the secondary circuit is as follows: The segment of switch which formerly connected *H* and *HM* has moved from contact and *H* and *HM* are no longer connected together.

The secondary winding of the coil is connected from terminal *M*, the ground, to a segment to the switch, which in battery position makes contact with the *H* terminal.

Secondary current now flows from secondary to H , to distributor arm, to firing plug, to ground, and through grounded terminal M on coil to opposite end of secondary winding.

The timing of the Eisemann magneto is very simple and the usual dismantling of the instrument to measure the armature distance, or eye-straining observation of the breaker points is eliminated. It is necessary only to bring one of the setting marks which is on the distributor disc up to the pointed screw at the top of the gear housing and couple up the drive, the piston of No. 1 cylinder being at the top of its compression stroke.

This will apply, of course, only to magnetos in which it is positively known that the pinion on the armature shaft is properly meshed with the distributor gear.

The opening of the interrupter points should be .3 mm., which is approximately .012 inch.

In some Eisemann magnetos, contact points of crecium have been used. In other magnetos contact points of platinum have been used. Crecium and platinum points will not operate against one another. The crecium and platinum points may be distinguished from one another by the fact that the crecium points used were $\frac{3}{16}$ inch in diameter, while the platinum points used were $\frac{5}{32}$ inch in diameter. Therefore, two $\frac{5}{32}$ -inch points will operate together very satisfactorily and two $\frac{3}{16}$ -inch will operate together; but

two $\frac{3}{16}$ -inch points will not operate together. The breaker or interrupter is so placed, or so

adjusted, that its opening is 0.012 inch greater than the opening of

PRELIMINARY BENCH TESTS

For many of the quick tests for the purpose of ascertaining if certain parts of the ignition apparatus, such as windings, are in condition, the following apparatus is advised: For coils of over 24 ohms resistance up to several hundred ohms resistance, 220 volts, direct or alternating current if available. If 220 volts are used, one 110-volt, 16-c.p. lamp should be cut in series with each line—not both bulbs in series on one line. This is a safety precaution. Voltages as low as 32 volts may, if necessary, be used; but the results will not be as positive as if higher voltages are used. In absence of either of the above, a telephone magneto may be arranged to give quite satisfactory service. A magneto built to ring through several hundred ohms resistance, such as used on rural “bridging” telephone lines or regular wireman’s test outfit, is advised.

For testing condensers, use 32 to 110 volts (D.C.) if it can be provided. Place a lamp designed for either voltage in series with the line.

For testing condensers use 110 to 220 volts D.C. as before; see that the apparatus which you are testing is disconnected from all wiring, and place your D.C. test leads directly across terminals of condenser. If lamp lights, condenser is short-circuited. If lamp does not light, condenser is either open or all right. Remove test leads and quickly short across terminals of condenser; if slight “kick” or discharge is perceived, it will indicate that condenser has received and discharged its charge and is apparently in good condition. The only other defects which might exist in condenser might be of slightly higher or lower capacity than is intended.

Caution. If a direct current is used, the voltage of which is not steady or constant, there will be a slight flash noted

upon breaking its connection with the condenser. This will not indicate condenser trouble; the same will be noticed if A.C. were employed to test condenser, therefore, only D.C. is advised for condenser test.

A capacity-meter for the measurement of condenser capacity is a desirable instrument, but its cost is prohibitive in general repair work.

Remember these notes refer only to preliminary testing; these and other methods of testing will be referred to further as we take up other parts of apparatus used on the car.

GENERATORS

A generator is a machine for the production of electrical energy; and those considered for use on the motor car will depend for this production, generally, upon the movement of a conductor through a magnetic field—that magnetic field being furnished by an electro-magnet or electro-magnets. However, there are a few types of generators being built which are alternating-current machines and more properly belong under the class of magnetos; although they are used for lighting purposes.

These will be treated later in the course, and the generators which the following definitions refer to will be standard type, direct-current generators.

Definitions. The armature of a generator is that portion of the machine in which the current is produced.

A commutator on a generator is a device to change the direction of the connection of each coil toward a brush as the coil passes the brush. The brush is the device used to collect or deliver current from or to the commutator. The "neutral point" is the point in the field at which the direction of the current in the coil passing that point changes. The brush-collecting current from the commutator must be

so set that it will short-circuit the commutator bars belonging to any certain coil as this coil passes the neutral point in the field. This point is called the point of "commutation" or change.

There will be as many bars in the commutator as there are coils on its armature.

A shunt field is a field winding of such resistance and so connected that only a part of the output of the machine is led through the field from a positive to a negative brush.

Note. The resistance of the plain shunt field of 6-volt generators will usually vary between four and six ohms.

A series field is a field winding so connected that all the output of the generator must pass through the series field either on its way to or from the generator.

REGULATION OF GENERATOR OUTPUT

The control of the output of a generator driven at various speeds or at a constant speed with a varying load, is termed "regulation."

There are three things, primarily, upon which the output of a generator depends. These are, first, speed; second, field strength; third, number of turns of armature winding.

A variation of any or all of these things will affect a variation in the output of the generator.

The characteristics of the charging current of the generator used on the motor car for the purpose of charging a storage battery are very limited because: First, the generator is driven at variable speeds (devices for governing the speed of the generator have proven unsatisfactory); second, the load varies with the use of lights and the change in the condition of the storage battery; third, any method of regulation must be entirely automatic, and so arranged that it prac-

tically takes care of itself because of the fact that the ordinary driver of cars has not studied, and would not be able to operate, practically, any regulating device manually controlled.

Going back to the three important things which primarily govern a generator output, and analyzing them one by one, we are confronted with the following: First, that to regulate the output by means of governing the speed is very impractical, as it depends for its operation upon centrifugal action and some form of friction governor. This has been thoroughly tried out and nothing has been found which gives entire satisfaction; therefore, we eliminate the consideration of constant speed generators as a form of regulation. Considering the third item mentioned as being of primary influence—the number of turns of the armature winding; we can readily see that, with a machine in operation, any device to cut out or in more or less turns of the armature winding and thus vary the output of the generator would be so exceedingly impractical as not to deserve further consideration. Therefore, there remains yet but one item by which we can govern the output of a generator; and that is Item No. 2—the variation of the field strength.

It will, of course, be understood that, with a generator running at any predetermined speed, an increase in field strength means an increase in output—a decrease in field strength means a decrease in output.

Variation of the strength of the field lends itself very readily to our purpose for the regulation of generator output and forms the basis upon which all companies construct their different forms of regulating apparatus.

The variation of field strength, and through it the governing of the output of the generator, may be accomplished by any one of three ways, or by combinations of these ways.

First, to insert resistance or decrease resistance in the field circuit will decrease or increase, respectively, the output

of the generator. This method we shall term "regulation by inserting resistance."

Second, variation of field strength, and through it control of the generator output, may be accomplished by causing a current to flow in a direction around the pole piece or pole pieces of the generator in such a way that an increase in this reverse current will weaken the field strength of the generator and decrease its output; while a decrease in this reverse current will allow increase in field strength and increase the output of the generator. This method is properly called reversed series regulation, and a generator using this method of regulation is often termed a "differential-compound generator."

Third, there is a certain effect produced in a generator by the polarization of its armature called "armature reaction." Armature reaction acts in such a way that the field flux from the poles does not remain evenly distributed over the pole-face, but is distorted in such a manner that one edge of the tip of each pole becomes weaker as the output increases, and opposite side of the tip of the pole piece becomes stronger as the output increases. This is known as "field distortion."

We may add an extra brush to this generator, and so place it that it will collect or deliver current to or from a portion of the armature coils at the time these coils are passing the weak portion of the distorted field. Any increase in the output of the generator decreases the field strength at the point of field distortion, and the coils of the armature passing this point produce proportionately less current for delivery to the field winding through the extra brush and in this way accomplish the desired regulation of output of the generator.

On bi-polar generators, a third brush is usually added for this purpose, and this generator is popularly known as being of third-brush regulation.

Third-brush or field-distortion regulation seems particu-

larly well adapted for use on generators of motor cars as it is reliable, simple and cheap; and, therefore, becoming very popular.

This first method of regulation, that of inserting resistance into the field, may be accomplished by either a rise in the voltage of the generator, or by a rise in the amperage output of the generator, or by both combined. When affected by a variation in voltage, the regulation is often termed "voltage regulation." When affected by a variation in the amperage of the machine, the regulation is known as current regulation.

Regulation by reversed current, or a differential compound generator, depends upon amperage output and is known as current regulation.

Regulation by field distortion, depending for its armature reaction upon the output or amperage of the armature, is essentially, therefore, also current regulation.

CARE OF COMMUTATORS ON GENERATORS AND STARTING MOTORS

The purpose of the commutator having already been explained, the next important item is the care of the commutator. There is very little difference in the construction of commutators used on generators and starting motors, yet there is a difference in their method of care. Referring to starting motors only, we find that the armature runs only a small portion of the time that the engine is in motion; while the generator is usually driven continuously during this time.

Brushes used on generators are usually of some soft material, such as carbon or graphite, while brushes used on starting motors are usually of a harder, more homogeneous alloy which is of better conductivity than carbon or graphite.

Owing to the fact that the generator commutator is used a greater portion of the time, and owing to the character of the brushes, the mica insulation between the bars or segments of the generator commutator is usually undercut; but due to the fact that the starting motor is not used a great portion of the time, and to the character of its brushes, it is not customary to undercut the mica of starting motor commutators.

The armature of a generator or starting motor is usually supported by means of ball, roller, or plain sleeve bearings, and for the commutator to operate properly the circumference of the commutator must necessarily run true with the shaft bearing.

The wear of a commutator due to the fact that the brushes rest upon it while it is revolving causes the copper to be worn down to a point even with the mica insulation, or lower, allowing the insulation to protrude above the segments and to cause the brush to make poor contact with the commutator.

While "sanding" a commutator which is in the above condition may afford temporary relief from the trouble and allow it to operate for a time, sanding is not considered as the proper care under this condition. If possible, the commutator should be removed and a cut taken in a lathe.

In chucking the armature in the lathe preparatory to removing or taking off a cut; first, note whether the centers of the armature shaft are true. If the armature shaft does not run true, due to the fact that the centers have been battered in removing the end frame of the generator, or otherwise, before proceeding with the truing of the commutator, remove the armature, slide the tail stock back, place the armature in the "steady-rest" and with centering tool re-center the armature.

After having re-centered both ends of the shaft, if neces-

sary, replace the armature between the lathe centers and drive it by means of the lathe-dog with the commutator end of the armature away from and next to the tail-stock center.

See that the tool which you are going to use is ground and oil-stoned to a rounded point, as was described to you in the lecture. See that the lathe carriage is given its lowest possible travel per revolution of the armature. See that the armature is spinning at a speed of from 300 to 500 revolutions per minute, depending upon the circumference of the commutator (the greater the diameter of the commutator the less necessity for high speed).

We would suggest that in taking the first cut the tool be set at or about the center of the commutator, that you take a slight cut, feed the carriage by hand, as the tool sometimes runs deeper into the commutator as it passes across the commutator than when it first started in the cut. Take light cuts repeatedly until you have "leveled up" the commutator and after this leave the lathe tool set, not changing the cross-feed adjustment after taking your last cut.

Stop the lathe and turn the armature by hand until the mica insulation between the segments comes directly under the point of the tool; now, without changing your cross-feed adjustment, crank your lathe carriage back to the beginning of the cut and allow the tool to feed across the commutator three or four times with this setting. This will cause the tool to "trim" the mica to as nearly as possible an even point with the commutator segments.

Always feed the tool from the tail-stock and toward the head of the lathe.

Now, procure a strip of No. 00 sandpaper of width equal to the length of the commutator. With the armature spinning, grasp this strip of sandpaper so as to give it as nearly as possible an even tension over the commutator, and, as

the commutator spins, slowly rock the sandpaper across the commutator, at the same time drawing it lightly back and forth until the commutator assumes a fair finish.

If this commutator is to be used with soft brushes, proceed, unless otherwise instructed by the manufacturer, to undercut the mica between the segments of the commutator to a depth of about $\frac{1}{32}$ inch.

There are three ways by which mica can be cut.

Perhaps the most usual way is with a hack-saw blade which has been broken off and ground to a thickness equal to the thickness of the mica between the segments. This will be a slow and tedious job. Be careful in undercutting by hand that the blade does not slip out of the groove which you make, and scratch the bar. Be careful also that you remove the mica the entire width of the slot which you are making between the bars, as nothing is gained unless the mica is cleanly cut away the entire distance between adjoining segments. Some time may be saved by using a sharp three-cornered file to begin the formation of your groove in the mica at the end of the commutator. After having carefully undercut the mica between all adjacent bars, replace the armature between the centers of the lathe and again, as before, while spinning, polish its surface with a very fine sandpaper. You will now find that the slots which you have made are filled with dust of the sandpaper, mica, and copper. To clean, use a piece of hard wood which has been sharpened to a point and pull this through each of the slots to remove this dust, and afterward inspect each slot carefully to see that no minute particles of copper remain in the slots as this would possibly "short" the bars together.

A quicker way than the hack-saw method to remove mica from commutators, when it is to be done often, is to procure a small motor (say of perhaps $\frac{1}{2}$ h.p.) and attach to it a dentist's flexible shaft on which is chucked a No. 16, No. 18, or

No. 20 dental burr; the number of burr depending upon the width of mica between the bars which you are undercutting. Very little practice with this dental burr will teach you to nicely remove the mica from between the bars to a depth of about $\frac{1}{32}$ inch.

The Robins & Meyers Co. have manufactured a machine for undercutting mica from commutators. This is a machine using a very fine, pointed, four-cornered tool which runs at a very high speed and which can be adjusted to varying depths. It is carried by a sliding block or arm which is adjustable both for travel lengthwise and sidewise.

You will, perhaps, find it most often necessary to use a hack-saw blade, although either of the other methods are to be recommended where the work is of sufficient quantity to justify the expenditure.

Proceed as before to repolish the commutator in the lathe and to clean the slots thoroughly, as described. This armature is now ready to be refitted into the generator; after having cleaned, inspected and greased the ball or roller bearings with vaseline, or with some grease recommended by the manufacturer of the machine, see that the armature is fitted up as it was originally and install in the generator. If possible, do not allow the brushes to rest against the commutator until you sand them in one by one. For sanding in brushes, No. 100 Grit 100 Aloxite cloth is recommended. Never use a strip of cloth which is narrower than the brush. Lay the strip of cloth over the commutator with the sand side of the cloth out, and, pulling it tightly and as nearly as possible around the commutator, proceed to use the sandpaper as a band to roll the armature back and forth in its bearings, at the same time allowing the brush to rest on the sanded side of the cloth and continue this movement until the brush has been so sanded that, as nearly as possible, its full surface makes contact with the commutator. After

having sanded in all brushes in this way, remove the Aloxite cloth or sandpaper (never use emery or crocus cloth) and, if possible, use compressed air to blow all dust from out the commutator and out of the machine. See that all brush leads are tight, and properly connected and that none are allowed to come in contact with the metal portion of the machine and cause a ground. Be sure to see that the commutator cover inspection plate or band is properly and tightly in place. See that this cover is in place before the generator is placed on a test bench and tried out, as it sometimes happens that the placing of the inspection cover will accidentally short or ground a brush lead. Should the generator now reach the proper charging rate, as will be described later, the commutator job, on which perhaps two or three hours have been spent, is well finished.

ELECTRIC MOTORS

An electrical motor is a machine for the conversion of electrical energy into mechanical energy by means of the attraction and repulsion of the poles of its armature to and against the poles of its field.

The construction of the armature of a starting motor is almost identical with the construction of the armature of generators as we have explained under the subject of generators, the essential difference between the two being in the size of the armature conductors, and in the fact that a great many starting motor armatures are wave-wound, while many generator armatures are lap-wound.

The usual practice in the construction of starting motors was to use a very heavy conductor in the field and to carry the current first through this conductor and then through the armature, or the other way about, and this motor is usually termed a Series motor. It is called a Series motor

because it is so arranged that all of the current which passes through the field windings must also pass through the armature.

The Series motors will form the chief subject of study under starting motors, for the characteristics of a Series motor are such that it is well adapted for the cranking of an engine.

The Series motor is well adapted to the cranking of an engine because of the fact that the torque (turning or twisting power), up to the point of saturation of the field, increases with the load.

The resistance of a starting-motor circuit is very low and were it not for the fact that when the armature begins to revolve in its magnetic field, it begins to produce a counter E.M.F. which tends to oppose the battery current, the battery current would continually grow heavier through the circuit.

What really takes place is this: The rapid rotation of the armature of the motor in producing its counter E.M.F. acts against, holds back, or retards the inward flow of the battery current. This weakens the magnetic field of the motor, which, in turn, allows the counter E.M.F. to grow less with the result that the starting motor of the Series type will "run off" if not loaded.

When loaded, however, the increase in the load tends to slow the armature, causing the counter E.M.F. to grow less and allowing the inrush of the battery current to grow greater, producing a stronger magnetic flux in the field and the armature core, thereby, producing a much stronger torque on turning power.

The current path of a plain bi-polar Series motor is as follows: Through the field winding, magnetizing the pole-pieces and into a brush resting on the commutator. At this point this current divides and flows around the two halves

of the armature winding, reuniting at the opposite brush, and passing back to its source.

CUT-OUT RELAY

The cut-out relay is an automatic switch, the purpose of which is to close the charging circuit when the voltage of the generator slightly exceeds the voltage of the storage battery and also to open the charging circuit when the voltage of generator falls below the voltage of the storage battery.

(Do not confuse cut-out relay or its functions in any way with the functions of a regulator. The two devices may, in general appearance, resemble one another, but there is a great difference in the function which each performs. They may even be built together and yet each act separately. The points of a regulator remain normally closed, while the points of a cut-out relay remain normally open.)

The cut-out relay has two windings:

(a) A fine or voltage winding which is always connected to receive current from the positive to the negative of generator. The purpose of this fine or voltage winding is to magnetize the core of the relay and pull its points together, thus closing the charging circuit.

(b) A coarse or series winding which is connected in series with the charging circuit. When the generator is charging the storage battery, the charging current in passing through this series winding tends to help magnetize the core and hold the points firmly together. When the generator speed is slow and the voltage of the generator falls to a point slightly below the voltage of the storage battery, the storage battery immediately sends a slight reverse current through this series winding and it tends to neutralize the magnetism in the core due to the flux of the voltage winding and this allows

the spring tension to pull the points apart, thus opening the charging circuit.

Nearly every company manufacturing generators used a cut-out relay in the charging circuit. One exception, however, is the Delco Company, who close their charging circuit by means of their ignition switch and open their charging circuit by the same means. This is made possible on the Delco system by the fact that their motor generator is driven through an overrunning clutch and you will note when you turn "on" the ignition that you will hear a clicking sound. This is caused by the fact that the ignition switch closed the charging circuit and that the generator in running as a motor is causing the clutch to slip and make the clicking noise.

Cut-out relays are located in various places. Specifications for the Government trucks call for the location of the cut-out relay inside the generator. Many cars mount the cut-out relay on top of the generator, while others carry it upon the dash, and yet others combine it with the regulator.

Note. Again be cautioned not to allow your idea of a cut-out relay or automatic switch to be confused with a regulator or a circuit breaker. Adjustment of cut-out relays is explained in lecture and demonstrated in the practical work.

STORAGE BATTERIES

THEORY

We have studied earlier in the course of dry cells which we have placed under the heading of "Primary Batteries."

At that time, we made mention of the fact that we would later consider storage batteries, and these we placed under the heading of "Secondary Batteries."

The term "Storage Battery," as commonly used, is very

deceptive for the reason that the electrical energy is not really stored, but that in passing through the solution used in the storage battery, it produces a chemical change in the solution and in the plates and in this way the electrical energy is said to be stored, while it is in reality in the form of chemical energy.

The fact that a current of electricity is a decomposing agent makes possible the present-day storage battery.

We are familiar with the fact that water is a composition, it being composed of two atoms of hydrogen uniting with one atom of oxygen. This is not a mixture, but a chemical combination and this composition which we term water is chemically written H_2O . The hydrogen and oxygen are known as "elements."

We may send a current of electricity through water and in this way separate its elements, or decompose it. If we should send a current of electricity through a glass of water, at the point of wire or electrode, where the electricity enters the water, bubbles of oxygen gas will be given off and at the electrode where the electricity leaves the water a great number of hydrogen bubbles will be given off.

If we were able to retain both these hydrogen and oxygen bubbles and to allow them to reunite in the proportions of H_2O , we should again have water and in the formation of this water a current of electricity would be given off.

The usual construction of storage batteries is but a modified application of the above principle.

Specific gravity is the weight of any certain volume of a substance as compared with the weight of a like volume of water. For any given volume of water at a certain temperature we would say the specific gravity of water is 1.00. In comparing a like volume of any other substance to this, if the weight of this substance is greater per given volume, the gravity of this other substance will be greater than 1.00.

If the weight is less than that of the given volume of water, its gravity will be said to be less than 1.00.

Sulphuric acid (H_2SO_4) is a very poisonous and corrosive acid formed of hydrogen, sulphur and oxygen in proportion of two atoms of hydrogen, one atom of sulphur to four atoms of oxygen. The specific gravity of chemically pure sulphuric acid is about 1.825, or nearly twice the weight of an equal volume of water.

In our storage battery we are going to use as our "electrolyte" a mixture of sulphuric acid and water in proportions of about two parts of acid to five parts of water. In mixing acid and water, the acid being heavier will naturally fall to the bottom of the vessel until the water and acid become thoroughly mixed, after which we will have a solution the gravity of which will be about 1.200.

In mixing acid with water, do not expect your gravity to be as high until the acid or electrolyte becomes cool. For every three degrees rise in the temperature of your electrolyte there will be a fall of one point in gravity. Therefore when the solution begins to cool its gravity will rise one point for every three degrees fall in temperature.

The gravity of the solution is measured by means of a hydrometer, which is a graduated glass bulb which will sink to a certain distance in any solution, depending upon the gravity of that solution.

The plates of a storage battery are usually of lead, although the Edison battery has plates of nickel-iron immersed in alkaline solution. Practically the only makes of storage batteries at present in use on motor cars are the lead-sulphuric batteries. Those batteries which are used for starting motor service will be composed of a number of thin lead plates immersed in this electrolyte.

The positive plates are cast in the form of grid and a paste of lead oxide is forced into this grid under pressure,

after which it is allowed to harden. The negative plates are pure gray lead. The process of charge is as follows: Current entering the positive plates passes through the solution of electrolyte from each side of the positive plate to a negative plate. In any cell of storage battery there is usually one more negative than positive plates. These plates, the positive and negative, are interleaved but separated from one another by separators of perforated hard rubber or by thin strips of corrugated wood, or both. More often the corrugated wooden strips are used and only one side of the wood is grooved or corrugated. The smooth side of the wood is placed against the negative plate, the corrugated side being against the positive, the corrugations or grooves being vertical in order that the loss of any material from the plate may be shed toward the bottom of the cell, which is a sediment chamber.

The cell box itself is made of hard rubber or some acid-resisting compound. The passage of the current from the positive plate through the electrolyte to the negative plate when the battery is "on charge" produces the following result: "The electrolyte is broken up or decomposed, bubbles of oxygen gas uniting with the positive lead plates form lead peroxide on the positive plate, while bubbles of hydrogen gas pass to the negative plates and the negative plates become sponge lead.

The decomposition of this electrolyte and the consequent removal of the water-forming elements, hydrogen and oxygen, by their combination with the plates and the leaving of the sulphuric in the remaining solution will, of course, explain the fact that as the process of "charge" goes on, the gravity of the solution becomes greater. The gravity of a fully charged lead-acid storage battery will be from 1.275 to 1.300.

Upon connecting the positive and negative plates together by means of a wire, a current of electricity will flow at a

pressure of about 2.00 to 2.6 volts. While this current is flowing from a storage battery, the storage battery is said to be discharging.

During "discharge" the following takes place in the storage battery: The positive plate, which has been resolved into lead peroxide, gives up a quantity of its oxygen, and the negative plate, which had become sponge lead, gives up a quantity of its hydrogen, and this oxygen and hydrogen reunite in the solution virtually forming water in the solution. Therefore, as the process of discharge continues, the gravity of the solution grows less. If this discharge continues, the gravity of the electrolyte may fall as low as 1.100 or even lower, but should never be allowed to fall this low, as when gravity reaches this point, lead sulphate forms very rapidly on the plates; the voltage of the cell becomes very low and the cell in this condition will readily freeze in cold weather.

The gravity of the cell should never be allowed to drop below 1.250, and should be maintained as nearly as possible at a point between 1.275 and 1.300.

The process of charge and the process of discharge should never be carried out at too high a rate as the chemical action taking place in the cell will produce a high degree of temperature and the plates will warp or buckle, allowing the active material to fall from them and to accumulate in the sediment chamber. This active material would not only mean a loss in the capacity of the plates, but would also accumulate until it might come in contact with the plates and form an internal short circuit of the cell, and the cell would immediately discharge.

A storage battery should never be allowed to stand in a discharged condition as the plates will sulphate very rapidly, and sulphation is the worst enemy of the lead-acid storage battery.

The process of mixing acid and water must be carried out

very slowly and very carefully. Never add water to acid. Always mix water and acid by pouring the acid slowly into the water and stirring continually, as in the chemical combination of the two a large amount of heat is evolved and were you to pour the water into the acid, you might be severely injured. Acid must always be handled in porcelain, glass, earthenware or lead-lined vessels.

Caution. Note this paragraph very carefully.

CARE OF STORAGE BATTERIES

Electrolyte. Make electrolyte in proportions of two parts acid to five parts water. Mix electrolyte by syphoning or slowly pouring the acid into the water and stirring constantly until you obtain a specific gravity of about 1.200. For every three degrees rise above normal temperature, that is, the temperature of your room, make an allowance of one point in gravity—to illustrate, if the temperature of your solution is only nine degrees above the temperature of your room, when the temperature of your solution falls to the temperature of your room, the gravity of your solution will have gained three points. Be again cautioned never to pour water into acid, but always pour acid into water. Remember that soda or ammonia will most effectively neutralize acid, in case of accident use freely.

Charging Battery. Determine condition of battery by taking gravity of each cell separately and by reading voltage of each cell when under a normal discharge load. In case gravity is low and all cells equal in gravity and voltage, place the battery on charge at the charging rate indicated on the name plate of the battery. In case of absence of name plate, it may be advisable to charge the battery at a rate equal to one-tenth its ampere-hour capacity, noting carefully that the temperature of the battery does not rise

excessively. In case the temperature does begin to rise, reduce the charging rate. By the use of a hydrometer read the gravity of each occasionally until a point is reached where the gravity ceases to rise constantly, then reduce the charging rate to one-twentieth of the ampere-hour capacity of the battery, or less, and allow the charging to continue until the battery is gassing freely. It is dangerous to break the charging circuit at the battery or to carry an open light near the battery when the battery is gassing. Remember that only D. C. may be used to charge the battery and that if A. C. only is obtainable, you will have to use some means by which you may rectify the A.C. to D.C.

In large installations, an A.C. motor driving a D.C. generator will be a dependable method of rectification. In small installations, a small mercury-arc rectifier may be used.

There are a number of commutating devices and hot filament rectifiers on the market, most of which are serviceable, but many of which are not economical. In arranging to rectify A.C., the following items must be considered: First, the number, voltage and capacity of the batteries to be charged; second, the values of your A.C., that is, voltage, phase, and number of cycles per second.

If D.C. is available, it will only be necessary to insert in the circuit some form of resistance, such as a bank of lamps, which will reduce the amperage of the circuit to the maximum amperage charging rate of the battery.

Sulphation. Formation of lead sulphate both upon the plate of the cell and upon the terminals of the battery will be one of the chief causes of trouble in the battery. The positive terminal is especially likely to sulphate. Clean the terminals with a brush and saturated solution of common baker's soda. Clean both the terminals of the battery and the terminals of the wires, rinse thoroughly, wipe dry, cover lightly with vaseline, re-assemble and bolt tightly together.

It is not best to scrape the lead sulphate, or corrosion off the terminal, as this will remove the lead coating on the taper terminal or upon the lug, which is usually made of copper or brass and plated with lead to prevent sulphation. Internal sulphation on the plates is caused by the electrolyte in the cell being low or by the battery standing in a partially discharged condition. Sulphated plates can usually be restored to active service by the battery being placed on charge at a very low rate until the sulphate covering on the plates become dissolved. In cases where the gravity does not rise after a continuous charge at a low rate for twenty-four hours, it is safe to assume that the cell is shorted, or so sulphated as to be worthless. In case it is shorted, it may only be necessary to install new separators, or wash the cell. In either case it will have to be opened.

To Open a Cell. With a twist-drill about equal in diameter to the diameter of the terminal post, drill the terminal post at the center of the lead connector to a depth which will allow you to pull the cell connector off the post. Remove the cell connector and, if the cell is simply sealed with a sealing compound, loosen the cover with a hot putty knife, or a baker's spatula which has been heated in a flame. Lift the positive and negative groups from the cell without disassembling, pour the remaining electrolyte from the cell into a glass or earthen retainer and if the cell box is hard to remove from the battery, loosen it by inserting the hot spatula between the cell and its mate, or between the cell and the wooden container. In case this is not practical, the cell may be loosened by pouring hot water into it. Remember that this cell is hard rubber, usually, and is very easily cracked or broken. Note, in removing the element from the battery that the negative will quickly heat when exposed to the air if in a charged condition. With a pair of tweezers, remove the old separators, take the elements apart and place the

elements separately in a dilute electrolyte. Install the new cell, examine the old separators and examine the plates. It is, of course, understood that the removal of the cell box is not always necessary unless the same should have happened to have been cracked or broken.

Lead Burning. *Preparation of work.* In all cases where lead burning is to be done, it is essential that the edges of the parts to be burned be cleaned. Otherwise, a scum of oxide will form on the molten surfaces of the metal, which will tend to keep the metal from flowing together, slow down the work, and quite possibly result in a very poor joint. Clean the edges and also clean the surface a short distance back from the edges, either with a lead scraper or with a wire brush. If any of the lead to be burned together has previously been subjected to the action of a strong acid, the acid on the lead should be neutralized before the burning is commenced. Sulphuric acid (commonly used in storage batteries) can be neutralized either by a weak solution of ammonia and water or a saturated solution of bicarbonate of soda (ordinary cooking soda).

Lead-burning Sticks or Filling Rod. In some cases, additional metal has to be fused in to completely fill the parts being burned or for building up the joint. Where extra metal is added, the "lead burning" sticks employed for this purpose are either pure lead or lead containing a percentage of antimony. Pure lead sticks are preferable for working on sheet lead or for any part which may be subject to bending strain, as, for instance, storage battery terminal posts.

Control of Flame. In all lead burning it must be remembered that the melting point of lead is low and that as soon as the metal reaches the melting point it will flow rapidly and unless care is exercised it will get beyond the control of the operator. Whenever the metal starts to run away, lift

the blow-pipe and allow the work to cool before attempting to proceed.

In all lead burning the chief thing to learn is to know when the lead is flowing properly and to lift the flame immediately from that part of the work so that no excess melting will be done. Some operators hold the tip of the inner cone of the flame on the work and others use the blue flame away from the blow-pipe tip, using the point of the inner cone only upon occasion. This is all a question of practice and skill, as well as a question of individual opinion on the part of each operator. Be careful, however, **not to jab the tip of the blow-pipe into the molten lead**, and under no circumstances hold the blow-pipe tip any closer to the work than may be necessary to play the tip of the inner cone of the flame on it.

Adding Extra Metal. When adding metal from a lead-burning stick the blow-pipe flame should be played on the stick and along the edges of the work to be joined at the same time, so that the whole work will reach the fusion point at about the same time. It does no good to deposit molten lead upon cold lead. All the lead must be melting; otherwise, it will not fuse together. Do not allow the lead-burning stick to touch the metal being worked upon, as it will stick and become firmly attached.

Burning Sheet Lead. *Lap Joints.* In burning sheet lead, it is always better, whenever possible, to lap the joints—that is, lay one sheet of lead $\frac{1}{4}$ inch to $\frac{1}{2}$ inch over the other, as this insures a strong and certain joint. The overlap of both sheets must be thoroughly cleaned and not merely along the edges. After placing the sheets in position, tap lightly with a wood mallet along the line of lap to bring the two sheets together. A lapped joint is burned without the use of lead-filling sticks. The blow-pipe flame is played along the edge of the overlapping sheet. With a little practice, this class of joint can be made at high speed.

Butt Joints. When the edges of the work are butted together (not lapped) it is possible to burn them together without the addition of metal from a lead-burning stick, and although this makes a very neat-appearing joint, the use of the lead-burning stick will insure a stronger joint, with less chance of leaving unburned spots in the seam. For a butt joint, the sheets must be cut true and must lay true while being burned. Tapping along the line of burning with a wood mallet about 6 inches ahead of the burn is desirable.

Tacking. Burn a small spot at each end of the seam, and if the seam is a long one, burn small spots about 6 inches apart along the seam, to keep the edges from pulling apart. This is especially important on vertical seams, but is also a very easy way of preventing the trouble that may be caused by the edges pulling apart on horizontal seams.

Blow-pipe Movement. The movement or play of the blow-pipe flame is largely a matter of choice on the part of the operator. Many operators prefer a slight circular movement, progressing along the line to be burned, while others prefer to play the flame alternately from each side of the line of burning. For the beginner, the circular movement is probably the better.

Vertical Seams. The joint should be lapped and tacked before burning.

Start from the bottom and work up.

Horizontal Seams. The joint may be butted or lapped. If strength is desired, use the lap joint.

Overhead Seams. The joints are lapped. These seams require high skill on the part of the operator, and considerable practice will be found necessary before a good burning and neat results are obtained.

STORAGE-BATTERY WORK

In battery repair work there are several operations that call for lead burning. It should be noted that great care must be used to see that the work is thoroughly scraped bright before burning and all oxide removed and traces of acid neutralized.

Burning Plates to Plate Connectors. The plates must be set up, properly spaced, and the plate-connector grid fitted over plate lugs. This setting up must be done in a burning rack or jig, which provides for proper spacing and true alignment. To burn, play the flame along the sides of the slots in the plate-connector grid. This will bring the grid and plate lugs to a melting point at the same time. Add metal from the lead-burning stick to fill up flush to top of grid. For lead-burning sticks, use antimonial lead if you know the plate connectors are made of antimonial lead; if you are uncertain, use pure lead.

Note. Antimonial lead after scraping has a silvery appearance as compared with the blue-tinged color of pure lead. Antimonial lead is also much tougher and harder to scrape or pare with a knife or lead scraper.

Burning Cell Connectors or Terminals to Terminal Posts. The connectors should be lightly tapped with a small wood mallet until they fit tightly around the terminal posts. To secure a good burn, it is necessary that the surface of the top of the terminal post be about $\frac{1}{4}$ inch below the top surface of the cell connector or battery terminal. If necessary, the terminal post should be cut off to insure this feature. To burn, play the flame on the top of the terminal post and bring it and the inner wall of the connector to a molten state, forming a bath. To the bath add metal from the lead-burning stick. As the bath fills up, be sure to watch that the metal on the inside wall of the connector flows into and with

the added metal. Continue adding metal until the added metal is flush with the top surface of the connector. Then allow the connector or terminal to cool sufficiently so that the lead will not crumble when brushed, clean up and finish the job. It is sometimes impossible to burn on a connector or terminal in one complete operation, as the heat developed inside the cavity usually causes the metal to overheat. In such cases, stop work as often as the lead seems to be running too rapidly to control, and allow it to cool before proceeding.

For lead-burning sticks, use antimonial lead if you know the terminal post is antimonial lead; if uncertain, use pure lead. In burning on any type of terminal in which the end of a cable is imbedded, protect the rubber insulation on the cable with a strip of wet cloth to avoid burning it. In battery repair shops, it is often necessary to build up a terminal post, which is drilled out when the battery is torn down.

When building up a terminal post, a mould should be used to hold the metal in place. This mould can be made of sheet metal and should be tapered so as to be easily withdrawn from the finished work. Be sure that the top of post is in a molten state before adding lead, so that the post and the metal added will be actually fused together. Unless this is done, the joint will be weak.

TROUBLE SHOOTING

Up to the present point our work in instruction has chiefly related to the construction and operation of each of the electrical units, considered separately. The term "Trouble Shooting" is used to designate the methods employed in localizing trouble on the car.

In the outline of Trouble Shooting, we shall, in order not

to miss any of the important circuits on the car, take them up in the following order:

- (a) Ignition Circuits.
- (b) Starting Motor Circuits.
- (c) Field Circuits of Generators.
- (d) Automatic Switch or Cut-out Relay Circuits.
- (e) The Charging Circuits.
- (f) Auxiliary Circuits such as Horn, Spotlight, Trouble Light, etc.

Before proceeding to check the ignition circuit, it will, of course, be necessary to know whether the ignition is battery or magneto.

IN BATTERY IGNITION

The accepted method for the localization of trouble is as follows:

Disconnect one end of wire which runs from secondary of coil to center of distributor and hold end close to terminal from which detached. Operate circuit-breaker point with finger or screw driver (if using screw driver, be careful not to cause a direct ground or short circuit, which might damage the primary of the ignition circuit).

If no spark is produced, examine switch and, if used, also the resistance unit. Determine the point to which the current flows in your primary circuit whether it be as far as the switch, coil or circuit breaker (timer). If you find that current travels up to the switch but not beyond, inspect switch for poor contact. If you find the current travels to the coil, proceed as has been described before to test the primary winding and also the ignition resistance unit, if the same be mounted on the coil. If current flows to the timer, inspect carefully terminal connections and more carefully the timer, interrupter or circuit-breaker points. Unless your primary

circuit is open, do not leave the ignition switch turned " on " any longer than necessary. After localizing the trouble in the primary circuit, if you have found it to exist in the coil or switch, proceed as described earlier in the course to test these parts.

Very often " opens " in the primary circuit will be due to sulphated battery terminals or loose or corroded battery ground connections.

TESTING HIGH-TENSION MAGNETO IGNITION

It is good practice to disconnect conductor which leads from collector brush to the center of distributor, if the construction of the machine permits this to be readily done. In many instances this conductor will be in the form of a pencil used on high-tension magnetos or on high-tension dual magnetos this conductor may be a secondary wire such as is used in the Eisemann system. Place this conductor or the spring which holds cover on safety gap close to, but not in contact with the magnets or other ground. Spin engine and watch for spark at this point. If no spark is produced, remove the armature lead, switch or ground wire and spin again. If spark now occurs, you will know that the trouble lays in the wiring or switch. Otherwise, the spark would not have occurred after the removal of the ground wire.

If, however, no spark is produced, examine the interrupter points. If the construction of the magneto is such that it is difficult to reach or to observe the breaker points, you may often be able to view them by the means of a small mirror.

If this, too, is inconvenient, remove the distributor and test with a screw driver or wire from the collector ring (as on Eisemann) or from the distributor arm (as on Dixie) for spark. Spark may also be tested at plug or end of plug wire.

A missing spark plug may be very definitely located by removing a plug in the cylinder which is firing and placing it in the cylinder which was failing to fire.

Methods of sending a pulsating current through the primary winding of a high-tension armature or an ignition coil by means of a battery and a vibrator, have been taken up earlier in the work.

In both high-tension magneto and battery-ignition systems, too much importance cannot be attached to the proper adjustment of the circuit breaker or contact points. Always be sure points are adjusted to the proper gap; note that they are not oxidized or burnt, or pitted; see that they are parallel when closed and that contact with each of the points is made as nearly as possible over their full surface; also that the contact arm, which is usually pivoted, is free to move on its pivot, but not worn, nor the pivot worn so that there is any lost motion. Note very carefully that in some magnetos, for instance the Eisemann, timer points of different material have been used in different machines. In others, as in this system, do not use a platinum point against a crecium point.

In this certain type of magneto the platinum and crecium points can be distinguished from one another, one being $\frac{5}{32}$ inch in diameter, and the other $\frac{3}{16}$ inch in diameter. Platinum will not operate against crecium or vice versa. A flaring yellow spark at the timer point accompanied by burning of the timer points does not always signify that the points themselves are in poor condition. A faulty condenser may also be the cause of this trouble. Test condenser, as has previously been explained.

STARTING-MOTOR CIRCUITS

Trouble in Starting-motor Circuits causing the starting motor to fail to crank the engine is more often due to sulphated battery terminals or weak batteries than to any other certain thing. Good practice for the localization of starting motor circuit troubles is as follows:

Turn headlights "on," step on starter pedal. If starting motor makes a feeble effort to crank the engine and during this time the lights grow dim, it will indicate that the storage battery is either down (partially discharged), or that there is a poor connection in the starting-motor circuit. Examine terminal connections of storage battery; treat same as described under storage battery to remove sulphate. A sulphated terminal will usually heat during the time that you attempt to use the starting motor. After removing the sulphate, try the use of the starting motor again and it will perhaps crank the engine very nicely. If, however, the lights should yet grow very dim, it will indicate that you either had a shorted armature or field in the starting motor, or that the battery is low.

By use of hydrometer, test the gravity of the storage battery or by use of voltmeter read the voltage of each of its different cells while the lights are on. Lower gravity or voltage in one cell than in others will, of course, indicate that certain cell as weak; low gravity or low voltage in all cells will usually indicate a battery which has not been properly cared for or one which is being used on a car where the charging current is too high, too low or is absent.

Inspect connections to starter switch, starter switch contacts, and inspect commutator of starting motor. If trouble exists in either of these places, proceed to repair same as described under these different subjects earlier in the course.

FIELD CIRCUITS OF GENERATORS

Before a generator can build up, it will have to have a complete field circuit. Failure to build up will usually be caused by open field circuits. Depending upon the method of regulation, the field circuit, if open and not burned out, will usually be open at one of the following places: Where a fuse is used in the field circuit, remove the fuse and inspect it. If fuse is "blown" there will have been a cause, usually an open circuit. While the charging circuit may be open, at any of many different places, it will usually be at the Cut-out Relay points or at the battery terminals. If field fuse is "blown," try to ascertain and remedy the cause before replacing the burned-out fuse with a new one.

Where inserted resistance is used as regulation and the resistance is inserted by means of a vibrating regulator, if the machine fails to build up, the trouble will quite frequently be due to the fact that the regulator points are not making proper contact.

Where the regulation used is field distortion of "third brush," opens in the shunt field circuit will often occur at the "third brush," as it frequently fails to make good contact with the commutator.

AUTOMATIC SWITCH OR CUT-OUT RELAY CIRCUITS

As the generator builds up, next in sequence comes the closing of the Cut-out Relay, in all systems where this is used. Failure of the Cut-out Relay system to close may be due to open voltage winding on the cut-out. In such cases, test out the voltage winding as described under Cut-out Relay. It may also be due to the fact that the cut-out points may close but fail to make contact. In this case adjust or clean the points as has been described. Failure of the cut-out points

to close may also be due to spring tension of the cut-out. Adjust same so that cut-out will close, as has been described at a point where the voltage of the generator is slightly in excess of that of the storage battery. On many cut-outs the voltage winding obtains its circuit by means of a ground through the mounting of the cut-out relay. Failure of the cut-out mounting to be grounded in such instances would, therefore, allow the points to fail to close with the result that the generator would be operated with an open-charging circuit and a consequent heating up or burning up of its field or the blowing of its field fuse. A good way to test for continuity of a charging circuit is to close the cut-out relay points by hand. Everything being normal, this will complete the circuit from the storage battery through the field and armature of the generator and the ammeter will show a discharge.

Should this discharge be slight, it will indicate, usually, an open armature circuit and a closed field circuit.

To test the field circuit in this manner, lift either the positive or negative brushes from the commutator and close the cut-out relay points by hand. If only a small discharge is noted on the ammeter and a slight self-induced arcing when you open the cut-out points, it will usually indicate that the shunt field circuit is O.K. With the generator charging circuit and shunt field both in good condition, the generator will tend to operate as a shunt-field motor. It can perhaps not do this, however, on account of being coupled to the engine. If the generator drive be uncoupled from the engine the generator will then motorize if in good condition when cut-out relay points are closed.

Some shunt generators will operate as a motor even with an open-shunt field circuit, but will have more speed and less torque when operating with an open shunt, as they are then merely running on residual field.

Abnormal brightening of the lights on the car when generator is in operation and engine speeded up, is usually due to an open charging circuit. An open causing this will usually be between the cut-out relay and the storage battery. Of course, if cut-out relay points fail to close, generator voltage will often run abnormally high, but lights will not flare up, for the lighting circuit is usually connected on the storage battery side of the cut-out relay points.

THE CHARGING CIRCUIT

The circuits we have just traced have also comprised the charging circuit. Instructions have been given under regulation telling you how to adjust charging rates with different forms of regulation. Check charging rates with an accurate ammeter inserted in series with the charging circuit. If, as in some machines, both motor and generator circuits are carried through one heavy lead, do not insert an ordinary ammeter in this heavy lead and then crank the car, for ammeter would possibly be burned out. Always by-pass the ammeter with a heavy connection, removing this by-pass after the engine is running to allow the ammeter to register the charging rate.

AUXILIARY CIRCUITS SUCH AS HORN, SPOTLIGHT, TROUBLE LAMP, ETC.

You will recognize in the auxiliary circuits on the car only a repetition of other ordinary circuits. Lighting circuits are usually protected by a fuse, but sometimes by a circuit breaker. Where a block of fuses is used the switch may be placed in position with "lights on" and you may use a "jumper" to close the circuit around each fuse in succession, until you come to the fuse which is blown, when you will

receive a heavy current through the "jumper," or the lamps will light as normally. If the lights operate normally, past the burned-out fuse with the jumper, it is safe to remove the old fuse and insert a new one. If, when you by-pass the burned-out fuse with the jumper, you get a heavy discharge, follow your lighting circuit until you remove the ground or short before replacing the burned-out fuse. Shorts or grounds in headlight circuits more frequently occur in the headlight connector sockets than in any other place in the lighting circuit. Bulbs may be changed from one socket to another to locate a burned-out bulb.

You will recognize in the motor horn a small series motor which is subject to the same troubles that cause many series motors to be inoperative. Commutator troubles, including brush trouble, brush-spring tension, poor adjustment of the cam or ratchet which engages the diaphragm of the horn, loose connections and poor horn button or horn switch contact are among the frequent causes of trouble in motor-driven horns. The horn circuit is often unprotected either by fuse or by circuit breaker as is also the trouble light circuit.

Spotlights are not usually installed upon cars at the present time as standard equipment. In most standard grounded electrical systems we will find a lead extending from the ammeter to the storage battery. It is customary to connect the spotlight circuit to the ammeter stud opposite that which leads to the storage battery, leading from this stud through the spotlight and spotlight switch to the ground.

Remember, as has been traced in a number of your diagrams that quite often the dash or cowl or instrument body light is connected in series with the tail light, thus a failure of either tail or cowl light will place both out of operation.

Caution. Do not press cut-out relay points together by hand unless prepared to open them quickly, as often the dis-

charge which occurs when they closed will heat them and thereby heat the spring of the cut-out and perhaps destroy the spring tension and also, if the points should be left closed with the engine not running, storage battery will discharge through the generator and cut-out and generator would both get hot.

Caution. Do not remove storage battery from car and operate generator with an open-charging circuit. For differential compound generators it is usually safe to short circuit the machine when driving without storage battery. If field fuse is used, it is safe to remove the field fuse and operate generator without storage battery. Brushes may be tied away from commutator, using string or cord, not bare wire. If the regulation is field distortion or third brush, only third brush need be raised off commutator and wires to battery taped. Short circuiting of some machines that are not regulated within themselves may cause the armature windings to heat and cause the commutator to "throw solder." If in doubt as to what practice or what course to follow, get down to "brass tacks" and find your field circuit and open it, or if possible, get the information on this certain machine from the manufacturer's manual if you can procure one. Remember this: Burned-out field windings result from open-charging circuits with machine under operation. Field windings are not only expensive, but will not always be in stock when required.

Caution. Disconnect ground connections of storage battery before working upon or tearing down parts on engine, especially near carburetor, as a short circuit or ground may very easily cause a flash which may set fire to dripping gasoline.

Caution. Do not "stand on" the starting switch when the engine refuses to fire. It will do no good to crank without spark and gas.

Caution. Do not crank with spark too far advanced.

Caution. Do not leave car stand over night with lights on, and never leave battery ignition turned on longer than necessary.

FIRING ORDER AND TIMING OF LEADING MAKES OF CARS

Abbott-Detroit.

34-40 and 44-50—Firing order 1-3-4-2.

Belle Isle—Firing order 1-5-3-6-2-4.

Magneto Setting—Piston dead center, lever fully retarded. Full advance, spark occurs with crankshaft 13° ahead of dead center. Contact point gap .018 inch.

Allen.

40—Firing order 1-2-4-3.

Magneto Setting—Piston top dead center, lever fully retarded.

American.

Scout—Firing order 1-3-4-2.

644, 646 and 666—Firing order 1-5-3-6-2-4.

Magneto Setting—Three-quarter inch after dead center on flywheel.

Arbenz.

Firing order 1-3-4-2.

Magneto Setting—Piston .03125 inch late, lever fully retarded.

Auburn.

4-40 and 4-41—Firing order 1-3-4-2.

Magneto Setting—Piston .03125 inch late, lever fully retarded.

6-46 and 6-45—Firing order 1-4-2-6-3-5.

Magneto Setting—Piston top dead center, lever fully retarded.

Buick.

B 24, 25, 36, 37, and 38—Firing order 1-3-4-2.

Delco—With timer cam fully retarded, spark occurs 40° past upper dead center on firing stroke. With hand spark lever half-way advanced, spark occurs at approximately top dead center.

B 55—Firing order 1-4-2-6-3-5.

Delco—Piston dead center with timer fully retarded.

Case.

25 R and 35 S—Firing order 1-3-4-2.

Magneto Setting—One thirty-second inch before top dead center.

40 O—Firing order 1-3-4-2.

Magneto Setting—One-sixteenth inch after dead center.

Chalmers.

24—Firing order 1-4-2-6-3-5.

Magneto Setting—One and one-half inches past center, lever fully retarded.

Chandler.

Six—Firing order 1-5-3-6-2-4.

Magneto Setting—Piston dead center, lever fully retarded.

Cole.

Four—Firing order 1-3-4-2.

Six—Firing order 1-5-3-6-2-4.

Delco—Piston dead center, distributor fully retarded.

Continental.

27—Firing order 1-3-4-2.

Magneto Setting—Three-quarter inch after dead center on flywheel.

Glide.

36 and 30—Firing order 1-3-4-2.

Westinghouse—Piston top dead center.

Grant.

M—Firing order 1-3-4-2.

Magneto Setting—Lever fully advanced, piston .3125 inch before top dead center.

Haynes.

28—Firing order 1-3-4-2.

Magneto Setting—One sixty-fourth inch advanced on down stroke.

26 and 27—Firing order 1-4-2-6-3-5.

Magneto Setting—One sixty-fourth inch advanced on down stroke.

Hudson.

6-40 and 6-54—Firing order 1-5-3-6-2-4.

Hupmobile.

32—Firing order 1-2-4-3.

Magneto Setting—Piston dead center lever fully retarded.

Imperial.

34 *F B*, 32 and 34 4 *M*—Firing order 1-2-4-3.

54 and 44-6—Firing order 1-5-3-6-2-4.

Magneto Setting—Points break with piston on dead center.

Inter-State.

45—Firing order 1-5-3-6-2-4.

Jackson.

Majestic and Olympic—Firing order 1-3-4-2.

Magneto Setting—Piston .125 inch before top center.

Sultanic—Firing order 1-5-3-6-2-4.

Magneto Setting—Piston .125 inch before top center.

Jeffrey.

93—Firing order 1-3-4-2.

96—Firing order 1-4-2-6-3-5.

Magneto Setting—Piston dead center, lever fully retarded.

Keeton.

F—Firing order 1-5-3-6-2-4.

Magneto Setting—Points break 6.5° before center.

King.

B—Firing order 1-3-4-2.

Magneto Setting—Points break with lever fully retarded from center to .5 inch past on flywheel.

Knox.

44 and 45—Firing order 1-3-4-2.

Magneto Setting—Piston .75 inch before top center, lever fully retarded. Battery, piston .375 inch before top center.

Krit.

L—Firing order 1-3-4-2.

Magneto Setting—Piston .125 inch before top dead center, lever fully retarded.

Lewis.

Six—Firing order 1-5-3-6-2-4.

Magneto Setting—Piston top dead center, lever fully retarded. Full advance equals .234375 inch of piston stroke.

Locomobile.

48 *L D* and *R D*, 38 *R D* and *L D*—Firing order 1-5-3-6-2-4.

Magneto Setting—Three-eighths to .4375 inch before top dead center lever fully advanced.

Lozier.

Four—Firing order 1-3-4-2.

77—Firing order 1-4-2-6-3-5.

Magneto Setting—Piston dead center, lever fully retarded.

Lyons-Knight.

K 4—Firing order 1-3-4-2.

Magneto has 6-inch range on 20-inch flywheel from 1 inch past center to 5 inches before.

Maxwell.

25-4 and 35-4—Firing order 1-3-4-2.

50-6—Firing order 1-4-2-6-3-5.

Magneto Setting—Points break with piston on dead center, lever fully retarded.

Moline-Knight.

26-50—Firing order 1-3-4-2.

Magneto Setting—Piston top dead center.

Moon.

42—Firing order 1-3-4-2.

6-50—Firing order 1-5-3-6-2-4.

Delco—Spark breaks on center in retarded position.

National.

40—Firing order 1-3-4-2.

Magneto Setting—Piston .0625 inch past top dead center, lever fully retarded.

Six—Firing order 1-5-3-6-2-4.

Magneto Setting—Piston .125 inch before top dead center, lever fully retarded.

Norwalk.

C and *D*—Firing order 1-4-2-6-3-5.

Atwater-Kent—Piston is .093 inch past center with distributor set at retard.

Oldsmobile.

54—Firing order 1-5-3-6-2-4.

Delco—Spark occurs at piston dead center with hand-spark lever fully retarded or .390625 before dead center with lever fully advanced.

Overland.

79—Firing order 1-3-4-2.

Magneto Setting—One and one-quarter inches after dead center (flywheel) lever fully retarded.

Packard.

2-38—Firing order 1-4-2-6-3-5.

Magneto Setting—Piston .5 inch before top center, lever fully advanced.

Paige.

25 and 36—Firing order 1-3-4-2.

Magneto Setting—Place No. 4 piston on top dead center (Compression stroke). Points should just begin to break.

Pierce-Arrow.

Sixes—Firing order 1-5-3-6-2-4.

Magneto Setting—Magneto mark on flywheel should be 4.8125 inches ahead of 1 and 6 top dead center and 1 showing in timing window. Piston is .5 inch before top dead center of 33° of crank circle. Battery spark occurs with piston 2.125 inches before top dead center or 75° of crank circle with spark lever fully advanced.

Pilot.

50—Firing order 1-3-4-2.

60—Firing order 1-5-3-6-2-4.

Magneto Setting—Points break with lever fully retarded and piston on dead center.

Pope-Hartford.

35—Firing order 1-2-4-3.

Magneto Setting—Piston top dead center. Maximum advance of magneto .5 inch on piston travel.

Premier.

6-48—and Weidely—Firing order 1-4-2-6-3-5.

Magneto Setting—Piston dead center, lever fully retarded.

Regal.

C, T, N and *NC*—Firing order 1-2-4-3.

Magneto Setting—Piston top dead center, lever fully retarded.

Reo.

Fifth—Firing order 1-3-4-2.

Remy System—Piston top dead center when indexing button on distributor engages.

Saxon.

A—Firing order 1-3-4-2.

Atwater-Kent—Piston dead center, distributor fully retarded.

Simplex.

38 and 50—Firing order 1-3-4-2.

Magneto Setting—Piston .015625 inch before top dead center.

75—Firing order 1-3-4-2.

Magneto Setting—Piston dead center or slightly after.

Speedwell.

H—Firing order 1-5-3-6-2-4.

Magneto Setting—Points break with piston at top dead center.

Rotary—Firing order 1-5-3-6-2-4.

Magneto Setting—One-sixteenth inch after top dead center, lever fully retarded.

Stearns-Knight.

Four—Firing order 1-2-4-3.

Six—Firing order 1-5-3-6-2-4.

Magneto Setting—Piston top dead center, points breaking.

Stevens-Duryea.

C 6—Firing order 1-4-2-6-3-5.

Magneto Setting—Figure 1 showing in timing window, 25° before top dead center (flywheel)

Studebaker.

Four—Firing order 1-3-4-2.

Six—Firing order 1-5-3-6-2-4.

Remy System—Spark occurs .75 inch after top dead center.

Velie.

5 and 9—Firing order 1-3-4-2.

10—Firing order 1-5-3-6-2-4.

Magneto Setting—Piston top dead center.

Winton.

Six—Firing order 1-5-3-6-2-4.

Magneto Setting—Piston .125 inch after top dead center, lever fully retarded and points breaking.

The lessons outlined on the following pages are taken from lesson sheets compiled to agree with equipment which may be used in actual work in school for student's practice.

These lessons are only suggested and should any school, using this book as a reference, not possess the equipment as outlined in the following lessons, similar lessons might also be arranged to cover the certain line of equipment possessed by the school.

AUTHOR'S NOTE.

LESSON NO. 1

SPLITDORF LOW-DUAL MAGNETO

1. Is this a high-tension or a low-tension magneto?
2. Dual, duplex or straight high?
3. Do interrupter points open primary circuit of ignition coil when switch is "on magneto" position?
4. Interrupter points should open .025 inch. Check same and see if correct.
5. For what purpose is heavy hexagonal stud on rear of armature box cover?
6. Why is terminal on front end plate not insulated?
7. What is purpose of terminal on side of breaker box?
Why is this insulated?
8. Where is armature lead terminal located?
9. How many revolutions of this armature to one revolution of crank-shaft of four-cylinder engine?
10. How many revolutions of distributor gear to one revolution of crank-shaft of four-cylinder engine?

Caution. If any parts are missing or, if for any reason this unit cannot be placed in first-class condition, make a written report, showing manufacturer's name, model number of machine; serial number and state reason you leave machine *not* in first-class condition. List any and all parts missing.

You are graded upon this.

The excuse "It was this way when I came on the job" absolutely will not be accepted. Any student falling back upon this excuse will be rated as careless and as lacking initiative.

LESSON NO. 2

**REMY LOW-TENSION DUAL-INDUCTOR TYPE MAGNETO-
TYPE S**

1. Is this revolving armature or inductor-type magneto?
2. At what speed, compared to engine-crank shaft, does this magneto shaft rotate?
3. Are these magnets simple or compound?
4. Do north poles of this magneto necessarily have to be placed on left side of magneto?
5. Why is the connection provided to center of this distributor head?
6. Explain how to adjust opening of interrupter points.
7. Find direction of rotation; advance breaker box and check position of high-tension distributor arm.
8. For what reason are the two leads brought out from under distributor head?
9. Is there a condenser used in this system? Why?
10. Explain the advantage you see in the secondary terminals used with this magneto.

LESSON NO. 3

**ATWATER-KENT, TYPE CC, CLOSED-CIRCUIT, BATTERY-
IGNITION DISTRIBUTOR SYSTEM**

1. What company manufactures this ignition system?
2. What type is this called—open or closed circuit?
3. Explain the method this company has adopted for timing this ignition.
4. Locate the condenser and tell how you would test same if:
 - (a) On the road.
 - (b) In the shop with proper facilities?

5. Contact points should open .006 to .009 inch. Check this opening.

6. Is this unit intended for "set" spark, automatic or hand advance?

7. For what purpose is the bare wire under cap of ignition coil?

8. Can the revolving distributor arm be mounted in wrong position? Why?

9. Is it possible to reverse the distributor head, and thus set firing order wrong? Why?

10. How is "ground" for this system secured?

LESSON NO. 4

ATWATER-KENT, TYPE "H" (ON CONNECTICUT BASE) OPEN CIRCUIT

1. Is this an "open" or "closed" circuit interrupter?

2. Who manufactures it, and what letter designates its type or model?

3. Why is no ballast coil or resistance unit used with this coil?

4. Points should open .006 to .009 inch, not to exceed .010 inch. *Be careful not to spring or bend* contact blade. Check and explain how you would adjust these points.

5. How would you time this system to engine?

6. Locate and explain how to test condenser.

7. How would you be able to tell if interrupter points *actually close*.

8. Why is this timer—distributor called a "uni-sparker?"

9. There are six terminal connections on coil; draw diagram of internal connections on this coil.

10. Procure "buzzer" from instructor, and note difference in "ring" through primary and through secondary.

LESSON NO. 5

WESTINGHOUSE VERTICAL-IGNITION, CLOSED-CIRCUIT BATTERY

1. With what number of cylinders is this unit intended to be used?
2. Could it be used with any other number without changes, except distributor head? Why?
3. May it be used R. H. or L. H. rotation?
4. How is it timed to engine?
5. Locate and explain how to adjust points.
6. Is any part missing from high-tension distributor arm?
7. Where is "safety-spark gap"?
8. Is this unit arranged for automatic or hand advance?
9. What is style and serial number of this unit?
10. Compare with diagram of Westinghouse vertical ignition unit in your instruction booklet, and explain how to test condenser, secondary and primary, without removing any of same.

LESSON NO. 6

REMY TWELVE-CYLINDER, CLOSED-CIRCUIT, BATTERY-IGNITION SYSTEM

1. Explain operation of the double-contact points.
2. Explain adjustment of points.
3. Locate and explain how to test condenser.
4. Disconnect condenser and observe spark at interrupter points. Also at secondary.
5. Note carefully construction of distributor head, and tell what precautions you would observe in handling same.
6. Test resistance unit alone without dismounting.

7. Test primary alone without dis-assembling coil.
8. Check firing order—starting with first secondary on left as No. 1—Left, and see that job is wired to fire as follows:
1 L—1 R—4 R—2 L—2 R—6 L—6 R—3 L—3 R—5 L—5 R. Left block No. 1 cylinder next to dash, right block No. 1 cylinder next to radiator.

If any mistake is found, call instructor before making changes.

9. Check and see if base of coil is grounded; and state whether or not it should be.
10. Tell how you would renew a burned-out ballast.

LESSON NO. 7

REMY FOUR-CYLINDER FOR CLASS B TRUCKS (CLOSED-CIRCUIT BATTERY-IGNITION)

1. How are secondary wires attached to distributor head?
2. Is contact "arm" or contact "screw" grounded?
3. For what purpose is the small flange or lip on the high-tension distributor arm?
4. For what voltage is this system intended? How do you know?
5. What is model and serial number?
6. Explain the advance mechanism.
7. Explain the proper adjustment of the points.
8. Is a ballast or resistance unit used?
9. Test primary. Test secondary.

Observe spark at points and at secondary with condenser disconnected.

10. Determine firing order, and list the number of places requiring frequent lubrication.

LESSON NO. 8

FORD MAGNETO IGNITION—LOW-TENSION DUAL, INDUCTOR TYPE

1. Is a high-tension distributor used with this ignition?
2. Measure distance between magnets and armature coils.
3. In what ways can you tell just how magnets should be mounted on flywheel.
4. Remove unit from coil box and test primary, secondary winding, and through points.
5. Adjust coil until meter in system reads 1.3 V.—and note carefully spark obtained with this reading.
6. How are armature coils connected with one another, in series or in parallel?
7. Tell how you would locate an open armature coil. Grounded armature coil.
8. Why is wire carried through heads of magnet mounting bolts?
9. Compared with the flywheel speed, at what speed does the timer rotate?
10. Check construction of timer and firing order.

LESSON NO. 9

BOSCH NU-4 HIGH-TENSION MAGNETO "COLLECTOR-RING" DISTRIBUTOR

1. Explain absence of regular type of distributor block in this magneto.
2. If one secondary lead should be pulled out of collector brush, how many cylinders would fail to fire on account of this?

3. If one spark plug in an engine equipped with Bosch NU-4 magneto was to become "shorted" what effect would this produce?

4. Is this secondary winding protected by a safety gap? Why?

5. Check position of cheek of armature cover to edge of pole-piece with opening of points.

6. Describe construction of breaker-box and tell that which you know regarding advance or retard of same.

7. What effect would be produced by a short circuit from secondary connection No. 2?

8. Is secondary winding on this magneto armature grounded?

(Determine this without removing armature).

9. (a) Swing breaker-box cover retainer spring aside.

(b) Remove breaker-box cover.

(c) Hold drive end of armature shaft with left hand.

With small wrench remove armature lead screw, after slipping breaker-box ring off and frame. Be careful not to twist armature lead screw (in center of breaker mechanism) off.

(d) Now place a very light screw driver on either side of breaker mechanism mounting disk, and very carefully pry breaker mechanism disk forward. (Note key stamped in rear boss on disk and note key way in recessed end of armature shaft).

(e) Now replace armature lead screw in end of armature shaft, screwing same in with fingers.

(f) Press *down* on collector brush holder retainer springs, and remove collector brush holders. Be careful not to lose collector brushes. Do not remove brushes, and *do not stretch brush spiral springs*.

(g) Remove the four screws, one from each corner of

the *drive end* frame, or plate. Note each screw and place it where it will not be lost, so that each screw may be put back in proper place. Grasp pulley in left hand and draw armature out of frame from rear end, and quickly insert a broad piece of soft iron between poles of magneto in armature tunnel to retain the flux strength of the magneto.

- (h) Grasp armature firmly in left hand (do not place in vice), and with wrench remove nut from drive end of armature shaft. With light piece of wood, tap pulley lightly and same will fall off tapered end of drive shaft.
- (i) Now lift rear-end plate from armature and be careful not to lose any spacing washers, etc., which *may* be assembled on armature shaft for purpose of preventing end play of armature.
- (j) Lay armature in cradle of test board, first seeing that test-board switches are open. See that armature lead screw makes contact with clips. Keep second, or condenser switch, open.
- (k) Now wrap piece of fine wire about one groove of collector ring, and place end of this wire *almost* ($\frac{1}{8}$ inch) in contact with brass segment in the second collector-ring groove. Turn core so that it will properly attract vibrating blade. Close switch No. 1, and note strength of secondary spark.

Experiment with this. Do not open secondary over $\frac{1}{4}$ inch. Do not keep vibrator in use continuously for over one minute at a time, as points will burn, this being a very *severe* test.

10. Now reassemble magneto, carefully following the foregoing procedure reversed. See that *ground* brush is in

place in rear of breaker disk when you replace it. After assembling *before driving*, call your instructor and he will check your work.

LESSON NO. 10

BOSCH DU-4 HIGH-TENSION MAGNETO

1. Why has the breaker-box cover a fiber disk on end?
2. With armature core just leaving pole-piece in direction of rotation, in what position should high-tension distributor arm be at time points just open?
3. Has this magneto any provision for advance and retard?
4. Remove pencil. Place safety-gap cover retaining spring close to magnet, and spin armature by hand (do not drive by belt now) and note if you get secondary.
5. Remove and inspect collector-brush assembly. Do not stretch brush spring and be sure to see that collector brush does not stick in guide.
6. Of what material is the base plate of this magneto made, and why?
7. Can you depend upon the arrow stamped upon the oil-hole cover on drive end of magneto to show you the correct direction of rotation? Why?
8. Can direction of rotation of magneto be reversed? If so, what is necessary? if not, why not?
9. What might be the probable electrical trouble which might develop should the distributor brush-carrying block be cracked or broken?
10. What is the purpose of the L and dot, also the R and dot stamped on bronze distributor gear? Are any other dots or markings necessary?

LESSON NO. 11

EISEMANN E.M.I.S. 4X HIGH-TENSION MAGNETO

1. Is this a high-tension, high-tension dual, high-tension duplex or low-tension magneto? How do you know?
2. Is this "clock" or "counter-clock" rotation? Could it be changed?
3. What is the purpose of glass "Peep-hole" in center of distributor cover?
4. What is purpose of brass screw in direct center of the distributor block? Is this usual construction?
5. Of what benefit is the slot in head of contact screw?
6. The recommended opening of these contact points is .3 mm. What is this in decimal of an inch?
7. Check and see if contacts open the proper distance.
8. Are these contact points of platinum or crecium? Remember dimensions given for Eisemann crecium and platinum points.
9. Does a high-tension dual magneto use a pencil?
10. Is there any difference in length of lower and upper magnet mounting screws?

LESSON NO. 12

BOSCH DU-4 HIGH-TENSION MAGNETO

1. What is the purpose of two screw-holes in each cam position in breaker-box ring?
2. If one cam in your breaker-box ring was worn low, and you could not procure a new one, how could you so repair it that your contact points would open the same distance when operated by either cam?

3. What would be the result if spring in breaker box failed to make contact with armature lead screw?

4. What should be used to lubricate bearings of these (and other) magnetos? Why?

5. Without using any scale or balance or known weight, test these magnets for flux strength and report their condition.

6. What will take place in the secondary circuit if magneto is operated with one or more secondary wires broken and with same not in contact with ground?

7. What is required for secondary circuits—heavy wire or heavy insulation? Why?

8. If your switch was "out of commission" how could you stop or prevent ignition on this type of magneto?

9. What would be the probable result of connecting dry cells to armature lead terminal and grounding the other lead from these dry cells?

10. What is a magneto which is properly arranged for this connection called?

LESSON NO. 13

SIMMS 4X HIGH-TENSION MAGNETO

1. What is the purpose of two advance arms on this breaker box?

2. Why is knurled part of high-tension collector brush holder enlarged?

3. Why is there a spring in pencil?

4. Why are magnets of this magneto stamped with mark "T"?

5. Why is there a fiber ring under breaker-box cover?

6. Why is there insulation around the terminal placed in the breaker-box cover retainer spring?

7. Should this insulation be omitted in building this terminal, what would be the result?

8. What advantage is claimed for extended Simms pole pieces?

9. What places on this magneto should be oiled?

LESSON NO. 14

DIXIE 6-42 INDUCTOR-TYPE HIGH-TENSION MAGNETO

1. In what respect does this magneto differ most radically from the "H," or shuttle, type?

2. Has it a pencil?

3. Has it an armature "Lead Screw"?

4. Is there any difference in strength of current in retard and advance position?

5. Is it necessary to remove *thumb* nuts in order to remove distributor block?

6. These points should never open to exceed 0.20 inch. Check same for opening.

7. (a) Get a large clean sheet of paper and spread it on bench, and weight it down so that it may not blow away.

(b) Concentrate your mind upon your "own business" now, and pay no attention to those working near you. **Pay attention to your own work only.**

(c) Remove the four screws holding the cover which is stamped "Dixie." Lift cover off and replace these four screws, making *sure* not to lose the small lock washers under these screws.

Remove the nut from the side plate stud which holds side plates at top. Draw stud out, and replace spring washers and nut. Lay aside.

Remove screws at bottom of each side plate; remove side plates and put the side-plate screws back in their proper holes, each with its washer under its head. Lay all the parts removed aside, and do not lose them. Now grasp magnets and draw them apart. Do not break the gap insulator in doing this. Place N. and S. poles together to "hold flux." You can now see exposed the condenser and the core carrying the primary and secondary windings. By the advance arm on breaker box, retard and advance the mechanism, noting movement of core which carries windings and condenser.

Now remove the screws which clamp the coil core to the soft iron field frame. Note that the screw on the left of the coil (viewed from drive end) forms the "ground" for the condenser. The primary winding is grounded to the core, and the secondary is grounded to the primary.

Next remove the two small brass screws which connect the brass strips on the right, to the coil, and coil may now be lifted out.

- (d) Replace these two small brass screws so that they may not be lost.

Draw the gap insulator out of its socket, or holder, and place where it will not be broken.

Inspect brush in center of distributor block gear and see that it does not stick in its tube.

Under the mounting of the coil, and between the soft-iron yoke or pole pieces, you will find a small cover plate with four screws. Remove same, and you may see the inductors, which are revolving element of the magneto. With the

breaker-box in different advance and retard positions, turn these inductors in the direction magneto is to be driven, until points just separate, and note that position of the inductors with relation to the pole-pieces correspond to the position of the cheek of an "H" type armature, but that retard and advance make no difference in the relative position of the inductors. This explains why the spark is of uniform intensity at retard and advance positions from the "Dixie."

(e) Reassemble carefully, and before putting side plates and cover on, call instructor and have him check you.

8. How would you remove the breaker contact arm?

9. How is current carried from primary to contact points?

10. What would be the result, if on the road the nut on the terminal on the breaker-box retaining spring should drop off, allowing wire it clamps to come off terminal?

Caution. If any parts are missing or, if for any reason this unit cannot be placed in first-class condition, make a written report, showing manufacturer's name, model number of machine; serial number and state reason you leave machine *not* in *first-class* condition. List any and all parts missing.

You are graded upon this.

The excuse "it was this way when I came on the job" absolutely will not be accepted. Any student falling back upon his excuse will be rated as careless and as lacking

LESSON NO. 15

DELCO IGNITION, CLOSED-CIRCUIT "BATTERY" SYSTEM

1. Remove distributor head, by pressing outward on "tongue" clip, and turning distributor head counter-clockwise, then lift up. *Do not break head.* It is made of bakelite, a composition of wood pulp, formaldehyde, and carbolic acid, and is easily broken. Inspect track and contacts in same for smoothness. Do not use any sandpaper, as this head *is in* proper condition. Inspect rotor brush and see that same does not bind.

2. Remove rotor and see that same is not cracked. Note that rotor can be placed on cam in one position only. Do *not* pull distributor brush or button out, neither pull button out of rotor as spring tension *is now right.*

3. Disconnect wires at each side of coil, and replace the terminal screws and lock washers.

4. Remove nut on inside of distributor housing on stud which forms terminal connecting to arm and also to screw.

In disassembling these two terminals be careful to note the exact *order* in which the insulators on stud are assembled, and after removing studs, reassemble insulators on studs in proper order, in order not to lose insulators.

There is one very small, yet necessary part missing in this contact assembly. What do you think is missing? Lift out thin insulating strip or liner of housing.

5. Loosen screw in center of cam. Lift cam off of shaft. Note that this ignition may be timed by loosening this cam screw, and shifting cam and rotor.

6. Note that the cup carrying contact mechanism is placed in the outer shell and held by means of a bayonet socket, or lock. Take small screw driver in each hand—

place end of one screw driver against coil and lift spring clip which holds bayonet stud opposite coil.

Pry against coil *lightly* with end of screw driver against *bayonet stud* next to coil, and cup will turn. Now lift up on cup, and same will slip up out of outer shell, leaving advance mechanism exposed to view. Note now on the shaft, plain flat spacing washer.—Do not remove this.

With screw driver, lightly pry governor weights apart, and you can see how the expansion of the weights by centrifugal force while whirling, will set cam shaft a little farther ahead in *direction of rotation*, thus effecting advance of spark automatically, as this causes points to open a few degrees earlier, depending upon speed. Now reassemble *carefully* in direct reverse to disassembling instructions above.

Better watch closely the position of the insulating washers and bushings in terminal stud assemblies.

Adjust carefully.

7. Test primary. (Buzzer.)
8. Test secondary. (220 V., A. C.; or D. C.)
9. Test condenser. (220 or 110 V. D. C.)
10. For what voltage is this system designed?
11. Test resistance unit. Do not disassemble same.

LESSON NO. 16

BOSCH DR-6

1. Remove screws which retain magnets. Note if the upper screws are longer than lower screws, or vice-versa, and after removing magnets, and placing them with N. and S. poles together to retain flux, put each screw back in its proper hole so that it may not be lost.

2. *Determine* if magnets need remagnetizing.

3. Remove high-tension connector and note *difference*

between it and usual type of "pencil." Do not drop it or break it.

4. Remove high-tension collector brush assembly (unscrew). Is anything wrong with it? If so, what?

5. Remove spark-gap cover. Is it all right? Why?

6. Take the two screws out of rear of armature-box cover. Why have they no lock-washers? Pull cover towards rear and remove.

7. Shove spring retainer aside from breaker-box cover; take cover off. Do not remove cam mounting ring. Turn armature shaft by hand. Does it bind or strike shoes of poles? Would it be safe to drive if armature was not free in tunnel? What would the result probably be?

8. What did you do with the two screws out of the armature-box cover? Why did you do this?

9. Make a written report, showing as nearly as possible, condition of this magneto as shown by your inspection.

10. Reassemble.

If you will look carefully you can see just how someone's carelessness has caused this armature to bind. Find why, and don't do the same thing.

Would you remove Woodruff key in drive shaft before trying to remove rear or drive end housing?

LESSON NO. 17

BOSCH MOTORCYCLE MAGNETO ZEV

1. Why is breaker-box cover attached to breaker-box ring with link?

2. How many magnets used upon this magneto?

3. Remove magnet retaining screws. If you turn magneto on side to remove these screws, be careful not to break the high-tension collector brush assemblies. It would be

best to remove the screws and take these brush holders off, then replace screws before proceeding farther.

Place soft iron keeper across magnet after removing.

4. Locate safety-spark gap.
5. Why is no regular type distributor board or head used on this magneto?
6. For what reason are the cams in this breaker box *not* spaced diametrically opposite to one another, as in the standard types of magnetos?
7. Is the spark to each cylinder of the same intensity as that to the opposite cylinder? Why?
8. Why are no lock washers used under the heavy base-plate screws underneath this magneto?
9. Is the core of this armature of laminated construction? Why?
10. Tell how you would test this armature in a vibrator such as is used here.

Reassemble.

LESSON NO. 18

STANDARD HIGH-TENSION MAGNETO TYPE M, NO. 1931 STANDARD IGNITION CO., ELKHART, IND., U. S. A.

1. What type, number, make and class magneto is this?
2. What two purposes are served by the nut on stud on name plate end of magneto?
3. Remove the above-mentioned nut; remove lock-washer which is under same and then pull the end plate on cover off magneto.
4. Observe location of condenser and state advantage or disadvantage you see in mounting same as it is mounted.
5. Is it necessary to remove any other parts than have

now been removed to ascertain whether the distributor gear and armature gear are properly meshed?

6. Pull forward evenly upon the breaker mechanism unit. What disadvantage can you see in this type of breaker mechanism?

7. If the thin copper contact spring extending through slot in breaker mechanism was bent far outward, what might the result be?

8. Remove hex nut at top of distributor head; also remove two screws in lower part of distributor head, pull distributor head forward to remove same from magneto. Why are no lock-washers used under these two screws last removed?

9. What is the disadvantage of the soft white metal used in making the housings of this magneto?

10. What is the purpose of the large covered coupling mounted upon the drive end of the magneto shaft?

11. Is a safety spark used with this system? If so, where?

LESSON NO. 19

"LOTENS" MAGNETO

Made by the Bridgeport Specialties Co., Bridgeport, Conn. Serial No. 736. Group No. 11,561. Type H-E

1. What type magneto is here represented?
2. Remove the magnet screws and note length as they are removed, and check the magnets to see if the poles are properly placed in relation to one another.
3. Remove the end housing which has the large brass hex nut and note the oil wick which projects into the sleeve bearing.
4. Tell how you would remove this oil wick in order to again insert the shaft in bearing.

5. Notice the plunger in the end housing assembly bears on end of armature shaft. For what reason?
6. Note tube with spiral spring inside of housing above plain bearing. What is its purpose?
7. If this magneto is intended for ignition, state for what system.
8. Why are there three sets of magnets and why are there many more turns in the armature winding than are commonly used on magnetos?
9. Tell where you would lubricate this machine.
10. Are the pole-pieces of hard steel or soft iron?
11. Why should brass screws or steel machine screws in soft metal never be turned down too tightly?
12. Are two north or two south poles ever attracted to one another? if so, when?

LESSON NO. 20

BOSCH TYPE D-6. HIGH-TENSION DUAL MAGNETO NO. 391910

1. What is the purpose of the brass clip which is riveted to the breaker-box cover?
2. Why is the breaker-box cover separated from the breaker-box ring by fiber insulation?
3. Facing the distributor board of the magneto, explain the purpose of the left-hand terminal stud upon the breaker-box housing.
4. Swing breaker-box cover, retaining spring to one side, lift breaker-box cover with insulation ring off breaker-box housing, lift cam assembly cover off breaker-box housing, turn armature in direction of rotation and observe opening of battery points.

5. What objection can you state to the fiber bushing in the contact arm of the battery breaker?

6. What is the purpose of the large insulator on the terminal stud in center of distributor board retaining spider?

7. How are the secondary wires fastened into the high-tension secondary terminals?

8. For what reason, do you think, are there three sets of magnets on this magneto?

9. Why is no pencil used in the high-tension circuit of this magneto?

10. How can you most easily ascertain whether this magneto is clockwise or counter-clockwise, and yet be absolutely certain?

11. Look under arch of magnets from drive end of magneto at bearing assembly of distributor gear shaft and explain the use of the "snap ring" which is used on the end of the distributor gear shaft.

LESSON NO. 21

BERLING MAGNETO TYPE F-41. U. S. MANUFACTURED BY ERICKSON MANUFACTURING CO., BUFFALO, NEW YORK

1. Spring distributor head clips aside and remove distributor head.

2. Remove revolving distributor segment by pulling straight forward and note that the high-tension pencil is part of same assembly.

3. Inspect brush in high-tension assembly and note method used by which revolving distributor segment is caused to revolve with distributor gear.

4. Would it be advisable to reverse the direction of rotation of this magneto by doing the following: Buying a clock-

wise breaker mechanism and resetting the distributor gear to the proper direction for clockwise rotation?

5. Why is a steel plate used to retain the magnet cover plate?

6. What advantage has a magneto constructed with a cover plate to hold the magnets in place, over a magneto on which the magnets are held in place by means of screws?

7. What would be the result if the two hex-headed screws at the drive end should be removed, or should be lost and not replaced?

8. What advantage has this construction? Has it any?

9. Locate safety spark gap and state reason that button side of gap is recessed.

10. Note that in order to remove armature, rear-end housing may be removed after the nut is taken off the drive shaft. Now spring the spring clip away from the armature lead screw and remove armature lead screw by means of small wrench, at the same time holding armature from turning with the left hand as you unscrew lead screw. With screw driver, pull lightly forward on contact mounting disk and remove same from armature. Note key-way in armature and key on disk and in reassembling, be sure that key on disk enters key-way in armature. Now draw armature from drive end of magneto.

11. Note rugged construction of condenser. Note connection of primary winding. Note which side of condenser is grounded, and tell how you would test condenser without removing same from armature. Note also the groove in pole-pieces and state reason for same. State how you will know that distributor gear is properly in mesh with armature gear in reassembling.

LESSON NO. 22

REMY DISTRIBUTOR UNIT MODEL NO. 4253. SERIAL NO. S-51

1. Spring distributor head clips aside and remove distributor head. Inspect head to see that it is not cracked; inspect plunger in center of head to see that it does not stick, and that contact is not badly worn; also, note whether high-tension distributor arm properly clears the high-tension points in the distributor head. Note number moulded in the head—54254.

2. Remove high-tension distributor arm. Carefully inspect same for crack or for evidence of current having arced across.

3. Turn cam shaft by hand until points open, check width of opening of contact points. Remove small cotter in contact-arm stud.

4. Place screw-driver behind terminal to which contact arm spring is bolted and pry this terminal lightly toward the contact arm; spring it out of contact groove.

5. Lift up on contact arm, removing same from stud. Unhook arm from spring and inspect contact point riveted in arm; inspect the bumper against which cam strikes and inspect bushing in arm which fits over contact-arm stud. Inspect bolt which bolts condenser lead to contact-arm spring. Pass condenser lead between contact-screw bracket and cam.

6. Remove screws holding condenser to distributor base plate and remove condenser.

7. Replace condenser hold-down screws in proper holes so that they are not lost.

8. Note that lock washers under same remain with screws.

9. With 110-V. D.C., test condenser from flexible lead to hold-down bracket for shorts or opens.

10. Loosen screw in center of cam shaft, pull cam off shaft. Turn distributor housing upside down and remove nuts and lock washers under advance lever. Place these together in small box so that they will not be lost. Remove advance arm and crescent-shaped spring under advance arm; also remove nut on stud passing through large washer directly opposite advance arm studs. Note three washers on this stud—do not lose same. Now pull distributor base plate out of housing. Note contact arm stud in base plate is insulated. Place contact arm on stud and note alignment of contact or interrupter points. Now replace parts, being careful to note that no washers are omitted under screws.

LESSON NO. 23

CONNECTICUT MAGNETO IGNITION REPLACEMENT UNIT NO. 16. MODEL 1230-F

1. Remove secondary wire from center of distributor head by pulling upward on same. Note small brass expansion ring on terminal in end of secondary wire. Note that terminal on coil end of secondary wire screws into secondary terminal in coil. Do not try to pull secondary wire out of coil—inspect same—right-hand thread.

2. Spring distributor head clips aside and lift distributor head off interrupter housing. Inspect same carefully for wear of center contact, cracks or misadjustment of high-tension terminal points.

3. Lift distributor or rotor off the interrupter shaft. Inspect same carefully for cracks or for burns from current arcing across, and carefully inspect for tension of contact spring on same.

4. Remove cover from coil. Disconnect wire which runs from "B" terminal of coil to the contact screw segment

CONNECTICUT MAGNETO IGNITION REPLACEMENT 101

in interrupter by removing nut on contact segment in interrupter housing. " B " terminal wire will now come out of interrupter housing; and you should replace nut and washer on terminal stud on end of wire.

5. Remove knurled nut on stud under advance lever, disconnect the wire from " A " terminal of coil at the interrupter.

6. Just opposite each end of contact arm, note machine screw in base plate of interrupter housing. Remove same, being careful not to lose lock washers. Remove hold-down ring and spring washer which are held down by these screws. Now, with fingers, grasp contact arm and lift contact plate assembly from interrupter housing.

7. Note stud on lower side of contact-plate assembly passes through bottom of interrupter housing and through advance arm underneath interrupter housing. Inspect condition of points and alignment of arm and screw.

8. Note that this contact arm is riveted on its stud. If necessary to renew contact points, instead of ordering contact screw for this model of Connecticut Ignition, order Model 16, Breaker Plate Assembly.

9. Primary winding in coil is connected between terminals " C " and " B ." Condenser located in coil is connected between terminal " A " and " B ." Secondary winding of coils is connected between terminal into which secondary lead screws, and ground clip or strip on side of coil.

10. Lubrication of timer shaft is accomplished by small cup directly under interrupter housing. Use nothing but vaseline in this cup. Reassemble, performing your operations exactly in the opposite manner to your disassembling.

LESSON NO. 24

DELCO GENERATOR AND IGNITION UNIT (COMBINED)

1. What system, or systems, are represented here; and how are they classified?
2. What class of ignition system is this?
3. How is the output of this generator controlled?
4. Is this a single-wire ground, or two-wire system?
5. Trace the ignition circuits from storage battery through complete system.
6. Trace charging circuit from internal circuit of generator through complete system.
7. What would be the results in the charging circuit if you would coast on a hill with engine in speed with ignition switch in off position?
8. What attention should the brushes and the commutator of a generator receive?
9. Why does the resistance unit in ignition primary circuit have only one terminal?
10. What is the clicking noise heard in generator when ignition switch is " On " ?
11. Why do they use " this " on this generator?

To Disassemble

Remove distributor head by holding out locating tongue on side of distributor housing which fits in groove in side of distributor head. Disconnect wires leading to generator. Remove band which holds coil to generator by removing clamp bolt in band. Remove band on commutator end of generator by loosening bolt in band. Remove four nuts located on housing on commutator end of generator but do not remove nuts which hold brush arm bracket in end of frame. Draw out end frame far enough to disconnect leads

from field to brushes. To remove clutch, take out four screws holding plate over clutch on drive end of generator. Remove plate and drive coupling, take a socket wrench and insert same on head of screw in end of armature shaft. Remove clutch by pulling straight out on same. Take hold of end frame on commutator end with left hand and pull out on same, thus removing both end frame and armature.

Reverse Operation for Assembling

LESSON NO. 25

DELCO STARTING MOTOR

1. What is the name of the manufacturer of this machine?
2. How do we open and close the circuit on this machine?
3. Trace internal circuits of this system.
4. What type of armature is used here?
5. Is this a bi-polar, or multi-polar motor? How can you tell?
6. What kind of drive is used here? Explain the principle of it.
7. What would be the results if the spring tension on brush arms was too weak?

To Disassemble

Remove band on commutator end by removing clamp bolt in band.

Next, remove end frame by taking off four nuts, holding end frame in place, pull out on same with both hands; but do not try to drive it off with hammer, as you might spring it.

Next, disconnect leads between fields and brushes by removing nuts on terminals—be sure to replace insulators, nuts and washers before doing anything more.

Next, remove brush arm bracket by removing four nuts on studs extending from housing.

To remove armature, remove housing on drive end of motor by drawing straight out on same, then disconnect sleeve on drive mechanism by removing cap screw going through same.

Be sure to replace all nuts and washers in their proper places and have all parts in a box provided by instructor.

To Assemble, Reverse Operation

LESSON NO. 26

LEECE-NEVILLE GENERATOR AND IGNITION SYSTEM

1. What make, and type of system is represented here?
2. Is this a single-wire ground, or double-wire system?
3. Trace out complete ignition circuits.
4. What is the purpose of automatic circuit breaker?
5. What instrument is contained under cover on side of generator, and what is its purpose?
6. Why do we use four brushes in this machine?
7. What form of regulation is used on this generator?
8. What is the object of the fuse located on bracket beside cut-out relay?
9. Trace out charging circuit, including internal windings of generator.
10. How do we change the output of this generator?
11. **To disassemble this unit, the following instructions should be carried out very carefully:**

Remove distributor by pulling out on clips on side of same.

To remove complete distributor unit, remove drive pulley from armature shaft, then remove the three fillister head screws from end housing, thereby releasing distributor-gear housing.

Remove attachment plug in button of cut-out relay mounting.

Remove ground wires on drive end of generator.

Now, start on commutator end of generator by marking end plate and generator frame with center punch marks to identify exact positions of same.

Remove five machine screws which hold end plate and generator frame together.

Next, drive pin from end of armature shaft.

Now, take hold of end plate and slide same out far enough to disconnect leads coming from fields.

Now, remove end plate and armature.

Be sure to replace any screws which you had occasion to remove in disassembling.

Test shunt-field windings and inspect parts for wear, or defects. Do not neglect giving this a very close inspection, as the instructor will ask you to give him a detailed report on same.

To Assemble, Reverse this Operation.

LESSON NO. 27

LEECE-NEVILLE STARTING MOTOR

1. What kind of machine is represented here? (Give manufacturer's name, model and serial number of machine.)
2. What type of motor is this? how are the fields connected in relation to the armature?
3. Trace out the complete circuit of this system.
4. How do we control the operation of this machine?
5. What form of drive is used on this motor? Explain operation of same.
6. Are there any good, or bad features about the switch on this motor?

7. Of what material are the brushes made?
8. Why do we use a larger conductor lead on this machine than on the generator?

To Disassemble

Remove nut and cap screw in drive end of armature shaft.
Remove complete driving mechanism.

Remove dust cover on commutator end of motor, by removing clamp screw in same.

To remove armature: First, remove end plate by removing six machine screws (be sure to mark position of end plate by center punch marks on main housing and end plate).

Disconnect leads between fields and brush brackets, then draw out on end plate; also, removing armature test.

9. Test armature on testphone used here for that purpose.
10. Test field windings for "short" or "open" circuits.

LESSON NO. 28

BOSCH DYNAMO AND LIGHTING SYSTEM

1. What form of regulation is used on this machine? Is it voltage or current?
2. Explain the principle of it.
3. How do we open or close our charging circuit?
4. Why do we use a field fuse in this circuit?
5. Is this a multi-polar or a bi-polar machine?
6. How are our windings in cut-out relay connected in the charging circuit? Explain the principle of it.
7. Is this a single-wire or two-wire system?
8. Trace the charging circuit from windings on the armature to the storage battery.

9. Trace the light circuit and tell whether it is grounded in switch or not.

10. Remove switch and test with buzzer or light with switch lever in all different positions.

To Dissemble

Disconnect four wires on drive end of generator.

Next, remove drive pulley.

Disconnect leads between fields and brushes, replacing screws that you removed from brush brackets.

Next, remove end plate on commutator end by removing two large screws in end; also, marking position of end cover with punch marks.

Next, remove armature by pulling straight out.

11. Test armature windings.

12. Test field windings to locate shunt and reverse series windings.

LESSON NO. 29

BOSCH FLYWHEEL STARTER

1. What causes the armature of this machine to draw in on the first part of the downward movement of the switch?

2. What causes the armature to spin on the completed downward movement instead of the first part of operation?

3. Is this a series or shunt machine?

4. Why do we use three leads on this system?

5. What is the object of drawing the armature into the machine?

6. What attention will the blades on switch require?

7. What causes the excessive heat on rear of switch? Is this a natural effect?

8. What possible trouble might develop if this circuit is left open when switch is in operation?

USEFUL DATA

DIMENSIONS, RESISTANCES AND SAFE CARRYING CAPACITY OF COPPER WIRES

| B. & S. Gauge No. | Diameter in Mils, or Thousandths of an Inch | Area in Circular Mils | Ohms Per 1,000 Ft. | Safe Amperes | |
|-------------------------|--|-----------------------------|--------------------------|-------------------|-------------------|
| | | | | Rubber Covered | Weather- proof |
| | 1000 | 1,000,000 | .01038 | 650 | 1000 |
| | 894 | 800,000 | .01297 | 550 | 840 |
| | 775 | 600,000 | .0173 | 450 | 680 |
| | 707 | 500,000 | .02076 | 400 | 600 |
| | • 632 | 400,000 | .02596 | 325 | 500 |
| | 548 | 300,000 | .0346 | 275 | 400 |
| 0000 | 460 | 211,600 | .04906 | 225 | 325 |
| 000 | 410 | 167,805 | .06186 | 175 | 275 |
| 00 | 365 | 133,079 | .07801 | 150 | 225 |
| 0 | 325 | 105,592 | .0983 | 125 | 200 |
| 1 | 289 | 83,694 | .1240 | 100 | 150 |
| 2 | 258 | 66,373 | .1564 | 90 | 125 |
| 3 | 229 | 52,633 | .1972 | 80 | 100 |
| 4 | 204 | 41,742 | .2487 | 70 | 90 |
| 5 | 182 | 33,102 | .3136 | 55 | 80 |
| 6 | 162 | 26,250 | .3955 | 50 | 70 |
| 8 | 128 | 16,509 | .6288 | 35 | 50 |
| 10 | 102 | 10,381 | 1. | 25 | 30 |
| 12 | 81 | 6,530 | 1.590 | 20 | 25 |
| 14 | | 4,107 | 2.591 | 15 | 20 |
| 16 | 51 | 2,583 | 4.019 | 6 | 10 |
| 18 | 40 | 1,624 | 6.391 | 3 | 5 |

TO DETERMINE THE SIZE OF COPPER WIRE FOR ANY GIVEN SERVICE

Let C. M. = Cir. Mils.

Let D. = Distance.

Let C. = Current.

Let L. = Loss in Volts.

21.5 is a "Constant" or figure always used.

$$\text{Then } \frac{C \times D \times 21.5}{L} = \text{Cir. Mils.}$$

EXAMPLE.—It is required that 100 amperes be carried 350 feet on a 110-volt circuit, with a loss of 2 per cent in voltage. What is the cir. mils required?

EXAMPLE.—First, ascertain the loss in volts, or 2 per cent of 110 = 2.2 volts.

$$\frac{100 \times 350 \times 21.5}{2.2} = 337,500 \text{ cir. mils or two No. 000 wires.}$$

Where a wiring table is not at hand and it is desired to ascertain the weight of any bare copper conductor, it can be roughly determined in accordance with the following:

One thousand feet of wire, having an area of 1000 circular mils, weighs approximately 3 pounds, and the weight of any bare conductor can, therefore, be determined by multiplying its area in circular mils by .003.

GALVANIZED IRON WIRE—WEIGHT AND RESISTANCE CALCULATED AT 68° F.

| Iron Wire Gauge | Diameter in Mils | Pounds per mile | Ohms Resistance per Mile | | |
|-----------------|------------------|-----------------|--------------------------|-------|-------|
| | | | E. B. B. | B. B. | Steel |
| 4 | .225 | 730 | 6.44 | 7.53 | 8.90 |
| 6 | .192 | 540 | 8.70 | 10.19 | 12.04 |
| 8 | .162 | 380 | 12.37 | 14.47 | 17.10 |
| 9 | .148 | 320 | 14.69 | 17.19 | 20.31 |
| 10 | .135 | 260 | 18.08 | 21.15 | 25.00 |
| 11 | .120 | 214 | 21.96 | 25.70 | 30.37 |
| 12 | .105 | 165 | 28.48 | 33.33 | 39.39 |
| 14 | .080 | 96 | 48.98 | 57.29 | 67.71 |

CONDUCTORS AND INSULATORS IN ORDER OF THEIR VALUE

| Conductors | Insulators (Non-Conductors) |
|------------------------------|-----------------------------|
| All metals. | Dry air. Ebonite. |
| Well-burned charcoal. | Shellac. Gutta-percha. |
| Plumbago. | Paraffine. India rubber. |
| Acid solutions. | Amber. Silk. |
| Saline solutions. | Resins. Dry paper. |
| Metallic ores. | Sulphur. Parchment. |
| Animal fluids. | Wax. Dry leather. |
| Living vegetable substances. | Jet. Porcelain. |
| Moist earth. | Glass. Oils. |
| Water. | Mica. |

According to Culley, the resistance of distilled water is 6754 million times as great as that of copper.

DECIMAL EQUIVALENTS OF EIGHTHS, SIXTEENTHS, THIRTY-SECONDS AND SIXTY-FOURTHS OF AN INCH

| Frac- tions of an inch | Decimals of an inch | Frac- tions of an inch | Decimals of an inch | Frac- tions of an inch | Decimals of an inch | Frac- tions of an inch | Decimals of an inch |
|------------------------------|------------------------|------------------------------|------------------------|------------------------------|------------------------|------------------------------|------------------------|
| $\frac{1}{8}$ | .015625 | $\frac{1}{16}$ | .265625 | $\frac{1}{32}$ | .515625 | $\frac{1}{64}$ | .765625 |
| $\frac{2}{8}$ | .03125 | $\frac{2}{16}$ | .28125 | $\frac{2}{32}$ | .53125 | $\frac{2}{64}$ | .78125 |
| $\frac{3}{8}$ | .046875 | $\frac{3}{16}$ | .296875 | $\frac{3}{32}$ | .546875 | $\frac{3}{64}$ | .796875 |
| $\frac{4}{8}$ | .0625 | $\frac{4}{16}$ | .3125 | $\frac{4}{32}$ | .5625 | $\frac{4}{64}$ | .8125 |
| $\frac{5}{8}$ | .078125 | $\frac{5}{16}$ | .328125 | $\frac{5}{32}$ | .578125 | $\frac{5}{64}$ | .828125 |
| $\frac{6}{8}$ | .09375 | $\frac{6}{16}$ | .34375 | $\frac{6}{32}$ | .59375 | $\frac{6}{64}$ | .84375 |
| $\frac{7}{8}$ | .109375 | $\frac{7}{16}$ | .359375 | $\frac{7}{32}$ | .609375 | $\frac{7}{64}$ | .859375 |
| $\frac{1}{4}$ | .125 | $\frac{1}{8}$ | .375 | $\frac{1}{4}$ | .625 | $\frac{1}{2}$ | .875 |
| $\frac{2}{4}$ | .140625 | $\frac{2}{8}$ | .390625 | $\frac{1}{2}$ | .640625 | $\frac{1}{4}$ | .890625 |
| $\frac{3}{4}$ | .15625 | $\frac{3}{8}$ | .40625 | $\frac{3}{4}$ | .65625 | $\frac{3}{4}$ | .90625 |
| $\frac{1}{2}$ | .171875 | $\frac{1}{4}$ | .421895 | $\frac{1}{2}$ | .671875 | $\frac{1}{2}$ | .921875 |
| $\frac{1}{4}$ | .1875 | $\frac{1}{8}$ | .4375 | $\frac{1}{4}$ | .6875 | $\frac{1}{4}$ | .9375 |
| $\frac{1}{8}$ | .203125 | $\frac{1}{16}$ | .453125 | $\frac{1}{8}$ | .703125 | $\frac{1}{8}$ | .953125 |
| $\frac{1}{16}$ | .21875 | $\frac{1}{32}$ | .46875 | $\frac{1}{16}$ | .71875 | $\frac{1}{16}$ | .96875 |
| $\frac{1}{32}$ | .234375 | $\frac{1}{64}$ | .484375 | $\frac{1}{32}$ | .734375 | $\frac{1}{32}$ | .984375 |
| $\frac{1}{64}$ | .25 | $\frac{1}{2}$ | .5 | $\frac{1}{4}$ | .75 | | |

HANDY TABLE

- Diameter of a circle $\times 3.146 =$ circumference.
 Radius of a circle $\times 6.283185 =$ circumference.
 Square of the diameter of a circle $\times 0.7854 =$ area.
 Square of the circumference of a circle $\times 0.07958 =$ area.
 Half the circumference of a circle \times half its diameter $=$ area.
 Circumference of a circle $\times 0.159155 =$ radius.
 Square root of a circle $+ 0.56419 =$ radius.
 Circumference of a circle $\times 0.31831 =$ diameter.
 Square root of the area of a circle $\times 1.12838 =$ diameter.
 Diameter of a circle $= 0.86 =$ side of inscribed equilateral triangle.
 Diameter of a circle $\times 0.7071 =$ side of an inscribed square.
 Circumference of a circle $+ 0.225 =$ side of an inscribed square.
 Circumference of a circle $+ 0.282 =$ side of an equal square.
 Diameter of a circle $\times 0.8862 =$ side of an equal square.
 Base of a triangle $\times \frac{1}{2}$ the altitude $=$ area.
 Multiplying both diameters and .7854 together $=$ area of an ellipse.
 Surface of a sphere $\times \frac{1}{2}$ of its diameter $=$ solidity.
 Circumference of a sphere \times its diameter $=$ surface.
 Square of the diameter of a sphere $\times 3.1416 =$ surface.
 Square of the circumference of a sphere $\times 0.3183 =$ surface.
 Cube of the diameter of a sphere $\times 0.5236 =$ solidity.
 Cube of the radius of a sphere $\times 4.1888 =$ solidity.
 Cube of the circumference of a sphere $\times 0.016887 =$ solidity.
 Square root of the surface of a sphere $\times 0.56419 =$ diameter.
 Square root of the surface of a sphere $+ 1.772454 =$ circumference.
 Cube root of the solidity of a sphere $\times 1.2407 =$ diameter.
 Cube root of the solidity of a sphere $\times 3.8978 =$ circumference.
 Radius of a sphere $\times 1.1547 =$ side of an inscribed cube.
 Square root of ($\frac{1}{2}$ of the square of) the diameter of a sphere $=$ side of inscribed cube.
 Area of its base $\times \frac{1}{3}$ of its altitude $=$ solidity of a cone or pyramid, whether round, square, or triangular.
 Area of one of its sides $\times 6 =$ surface of a cube.
 Altitude of trapezoid $\times \frac{1}{2}$ the sum of its parallel sides $=$ area.

FEET EXPRESSED IN DECIMAL PARTS OF A MILE

| | Units | Tens | Hundreds | Thousands |
|---|---------|---------|----------|-----------|
| 1 | .000189 | .001893 | .01893 | .1893 |
| 2 | .000378 | .003787 | .03787 | .3787 |
| 3 | .000568 | .005681 | .05681 | .5681 |
| 4 | .000757 | .007574 | .07574 | .7574 |
| 5 | .000946 | .009468 | .09468 | .9468 |
| 6 | .001136 | .011362 | .11362 | |
| 7 | .001325 | .013255 | .13255 | |
| 8 | .001514 | .015148 | .15148 | |
| 9 | .001704 | .017042 | .17042 | |

DIAGRAMS

DIAGRAMS

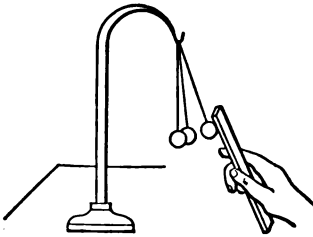

Iron Attracted by Magnet.

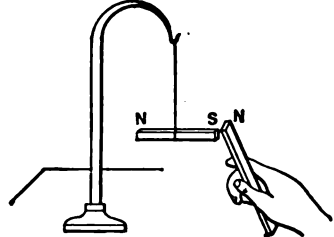

Attraction Between Magnets

Forms of Magnets.

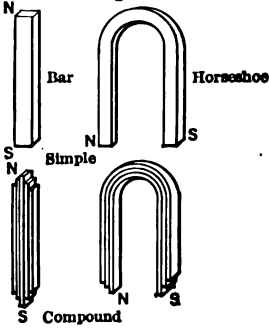

Fields of Magnetic Influence. Bar Magnet

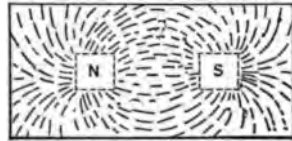
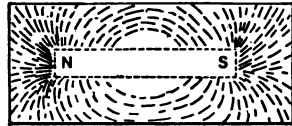

Horseshoe Magnet

Filings (Iron) Adhering to Magnets.

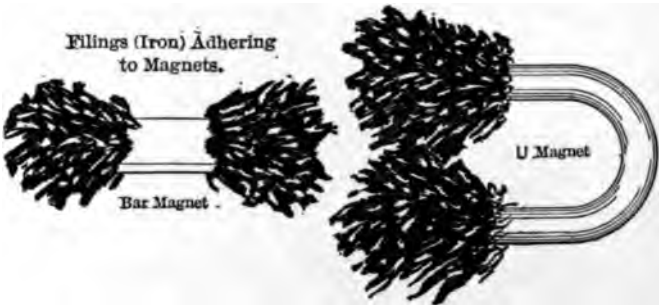

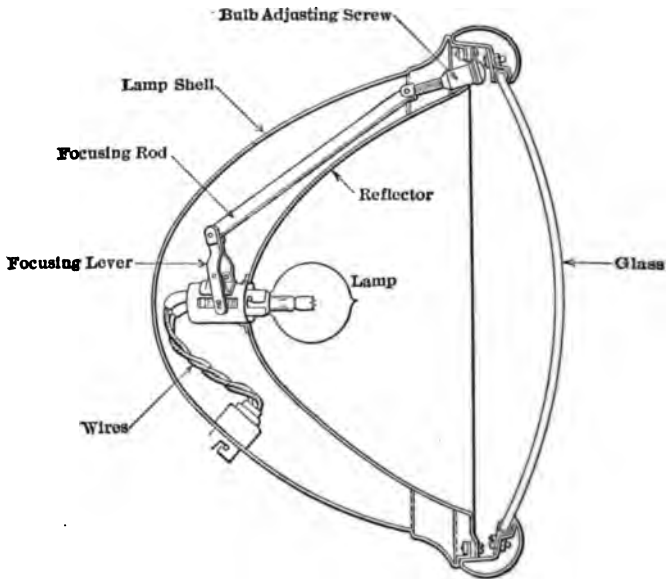

Showing Early Form of Focusing Arrangement for Use in Head-lights.

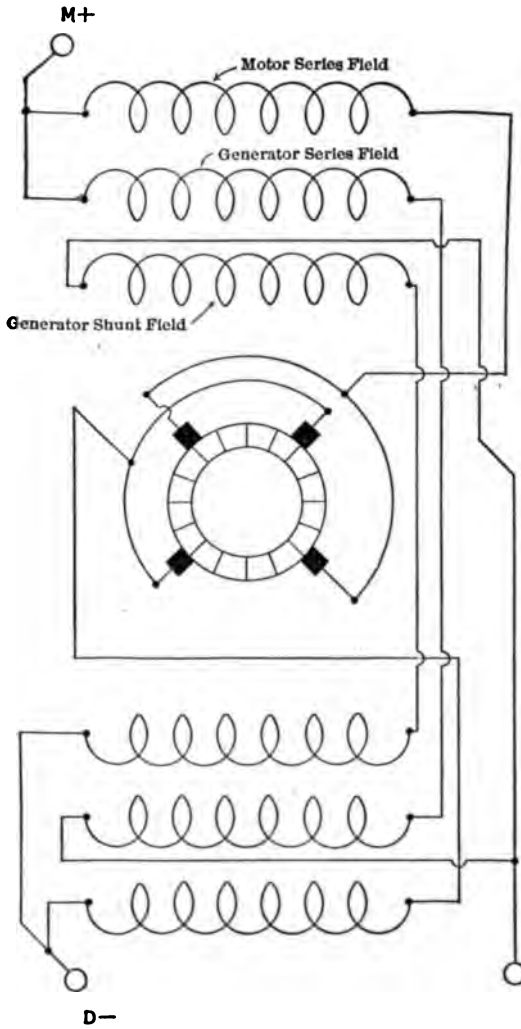

Apeldo Dynamo and Motor. Model No. A-25. $6\frac{1}{2}$ Volts.

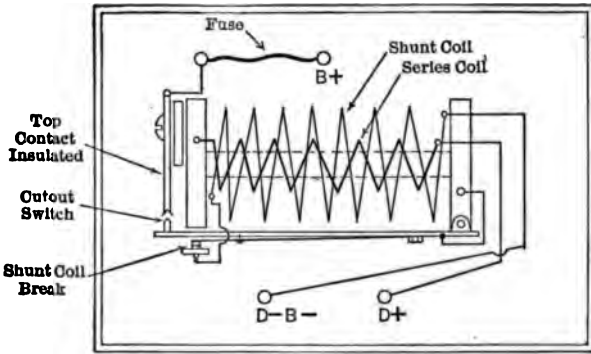

Apelco Automatic Indicating Switch for Model A-25 Motor Generator. 6 Volts.

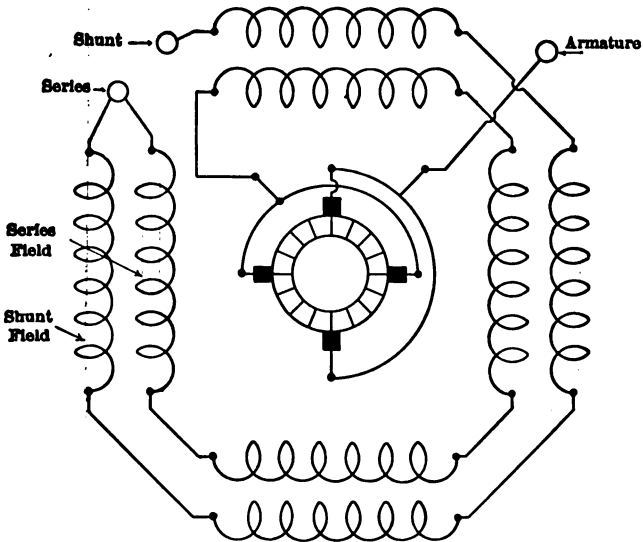

Allis-Chalmers Motor Generator. M. G. 16-L. 6 Volts.

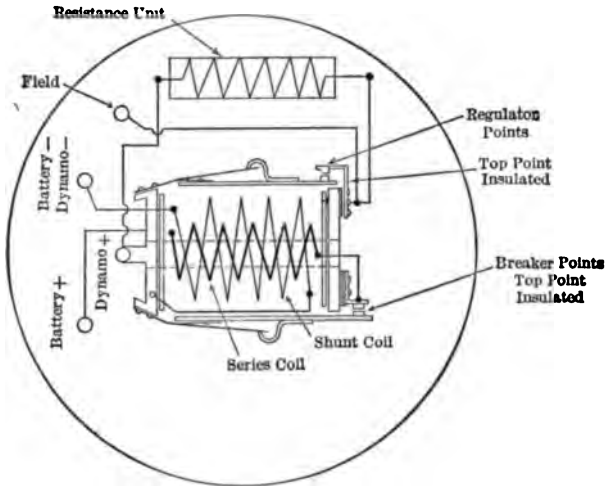

Allis-Chalmers Cutout and Regulator. 6 Volts. Dyneto.

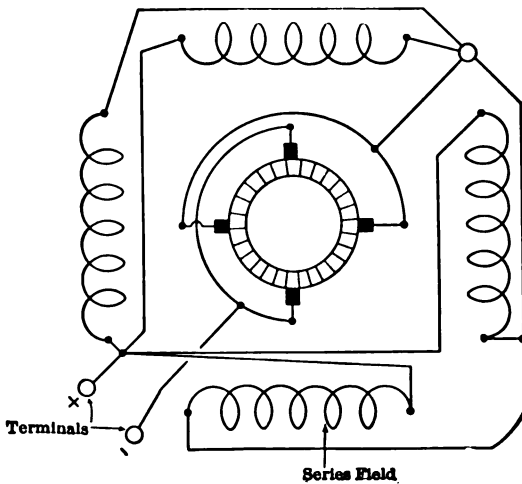

Bijur. Type E-6. M 254. Starting Motor. 6 Volts. Internal Connections.

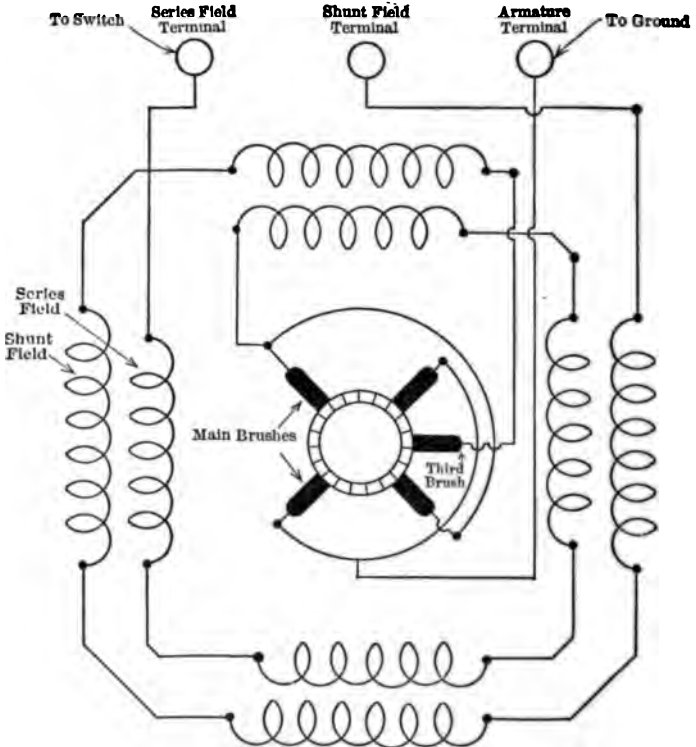

Bijur Motor Generator. M. G. 1213. 12 Volts.

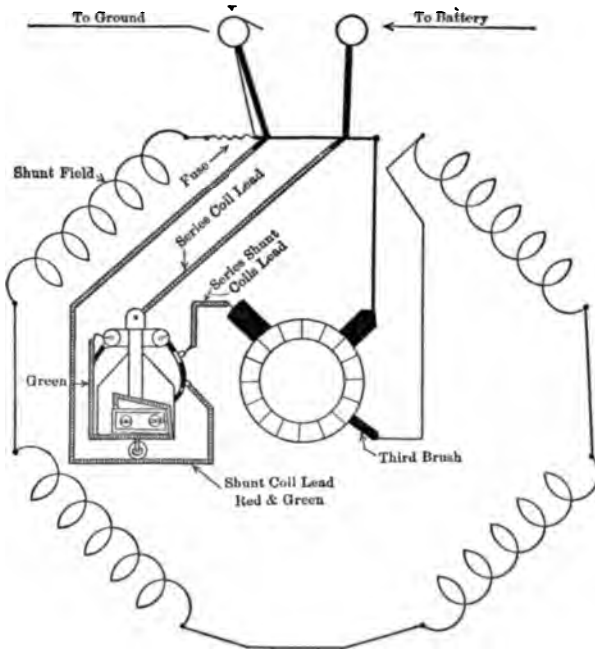

Bijur Generator. L-61. Grounded System. 3rd Brush. 6 Volts.

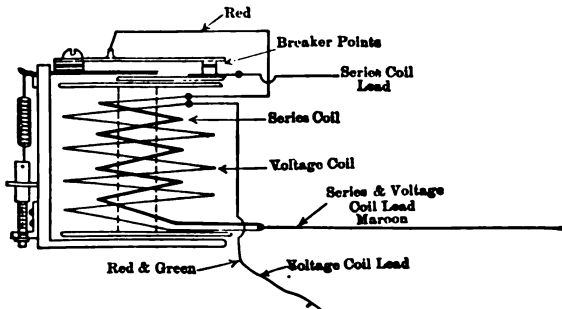

Bijur Cutout. For Generator Type L-61. 6 Volts.

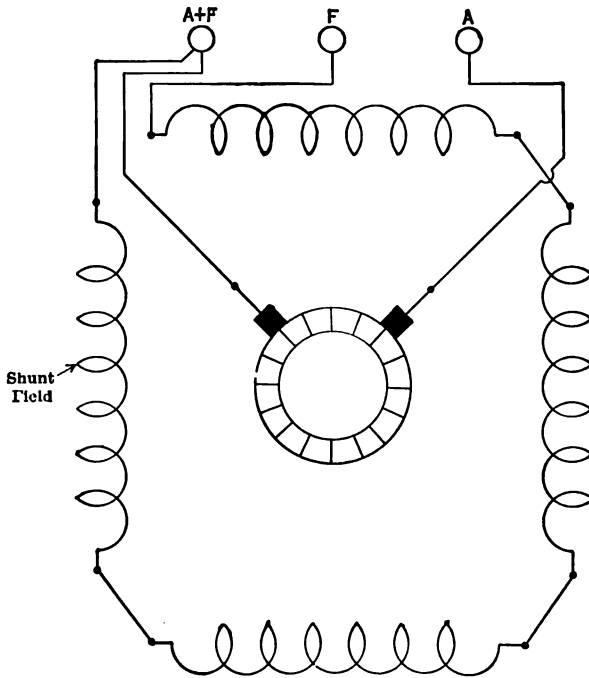

Bijur Packard System. Generator. M 35. Type H-62. 6 Volts

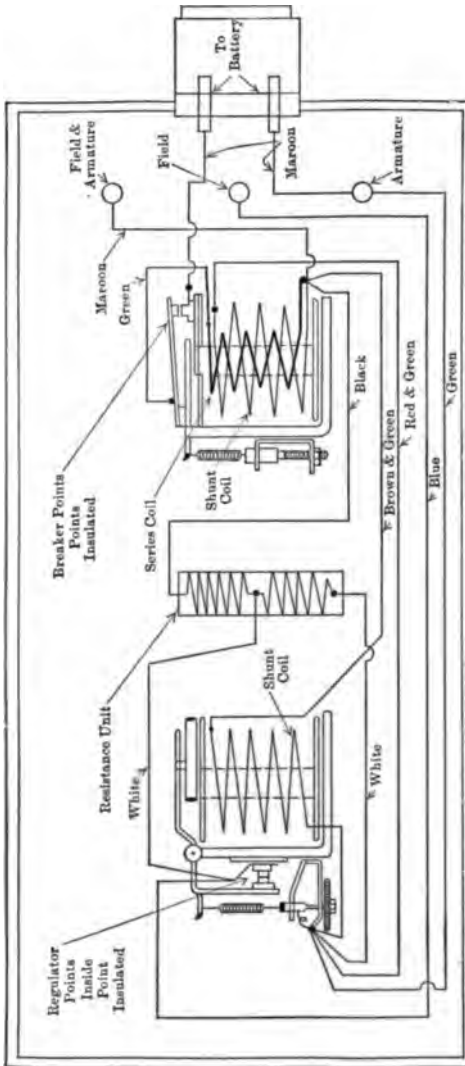

Bijur Cutout and Regulator. Packard System. R-75 B. For Generator. M-35. Type H-62.

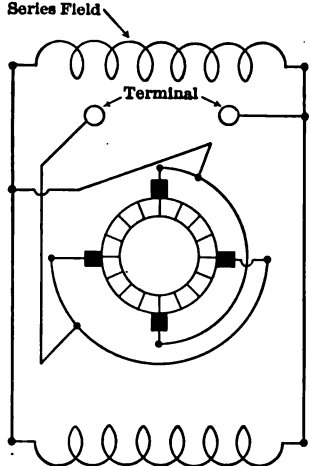

Bijur. Packard System Starting-motor. M-36. Type B-63. 6 Volts.

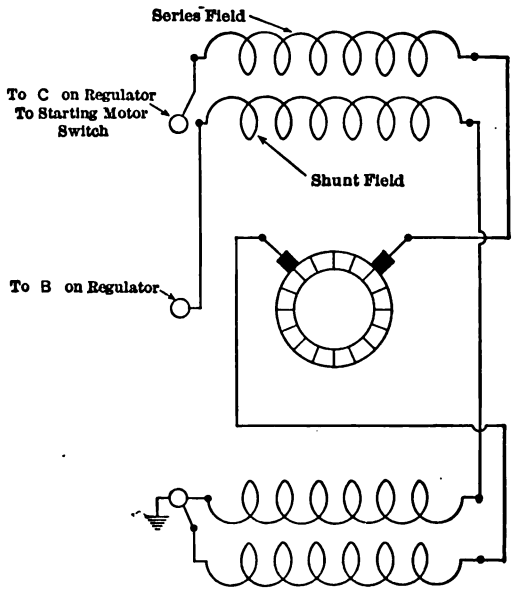

Disco Motor Generator. Model 26-A. 12 Volts.

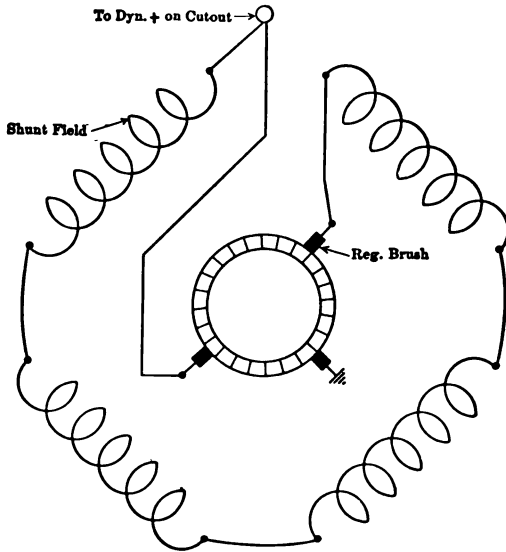

Disco Lighting Generator. Model 34-G. C. 6-Volts Internal Connections with Third Brush Control Cutout Diagram Below.

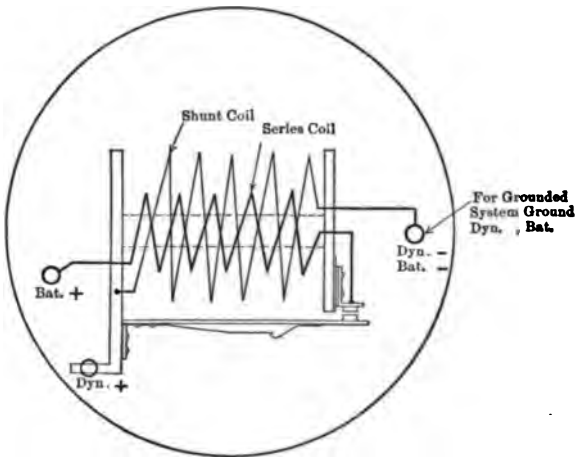

6-Volt Cutout. Used with the following Generators: Disco Third Brush Gen. Model 34-G. C. Diagram above. El. Auto Lite Type G. C.-G. D.-G. F.-G. H. Page 138.

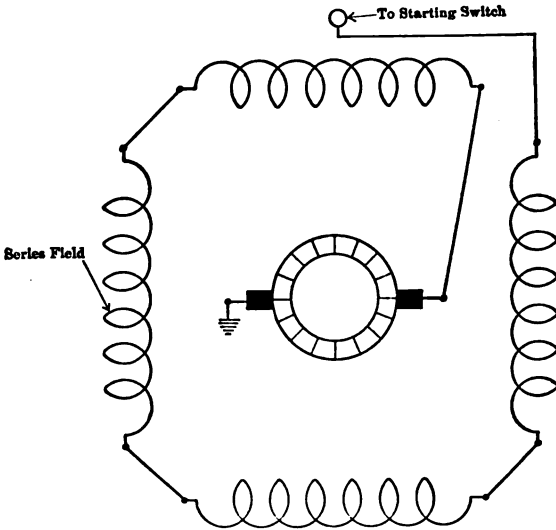

Disco Starting Motor. Model 32. 6 Volts.

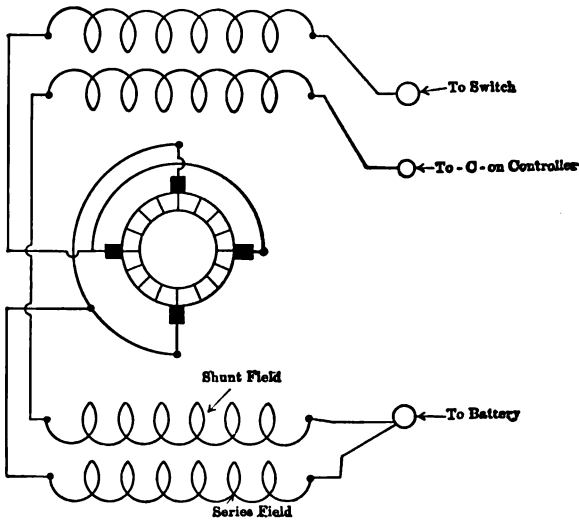

Detroit Starter Co. Motor Generator. No. R. S. 4595. 6 Volts.

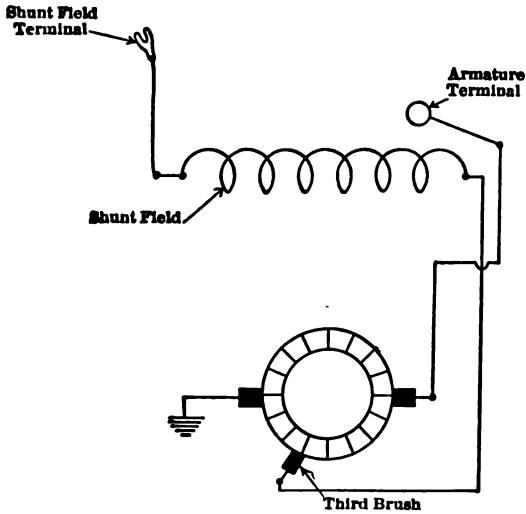

Delco Generator. Cole. 8-Cylinder. 6 Volts.

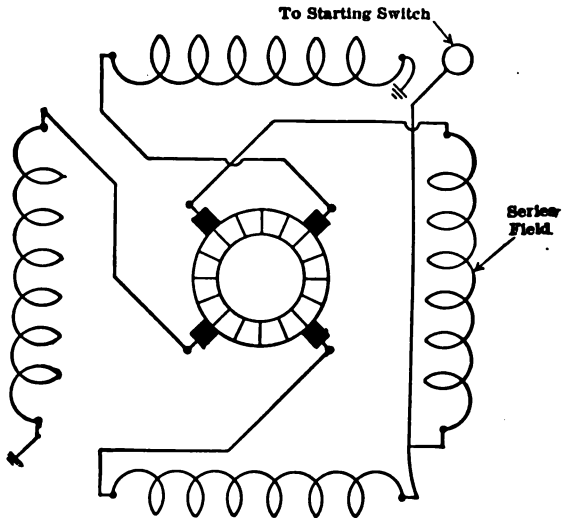

Delco Starting Motor. Oldsmobile. 8-Cylinder. 6 Volts.

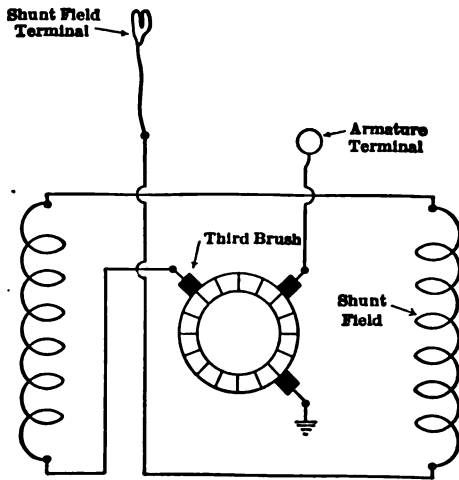

Delco Generator. Oldsmobile. 8-Cylinder. 6 Volts.

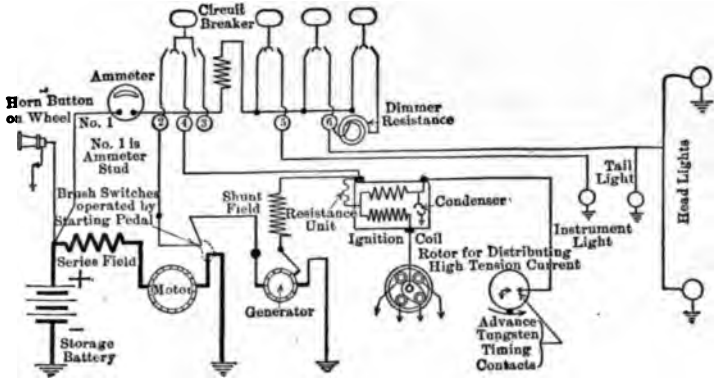

Wiring Diagram, Buick D-4 Truck. Delco System.

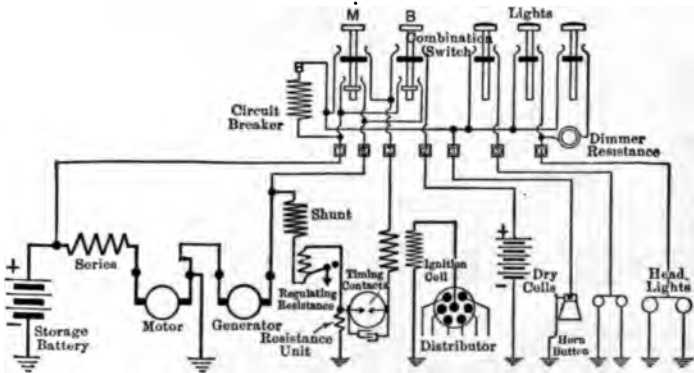

Buick 1915. Model C-54 and C-55. Delco System.

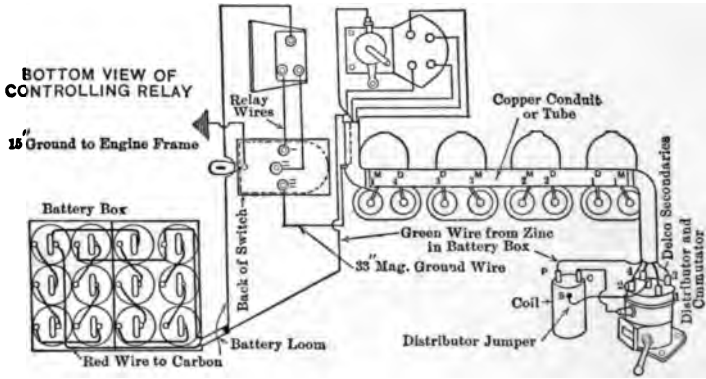

Ignition Coil No. 2022.
Ignition Switch No. 1001.

Distributor No. 5001.
Ignition Relay No. 5661.

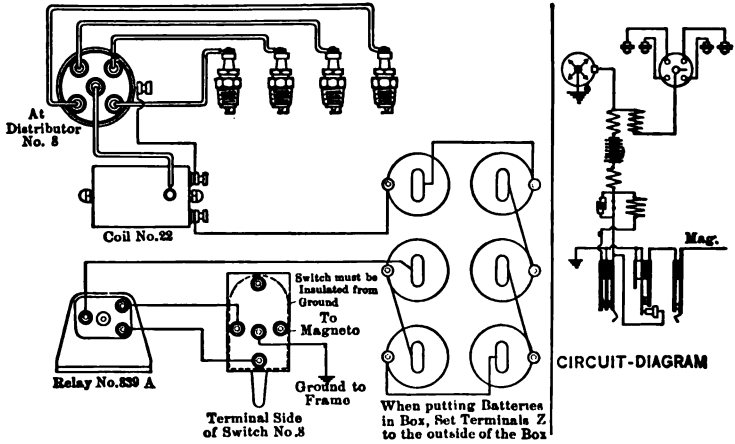

Ignition Coil No. 2022.
Ignition Switch No. 1009.
Cadillac, 1911 Model.

Distributor No. 5001.
Ignition Relay No. 5661.
Delco-Bosch.

Cadillac. 1914 Model. Delco.

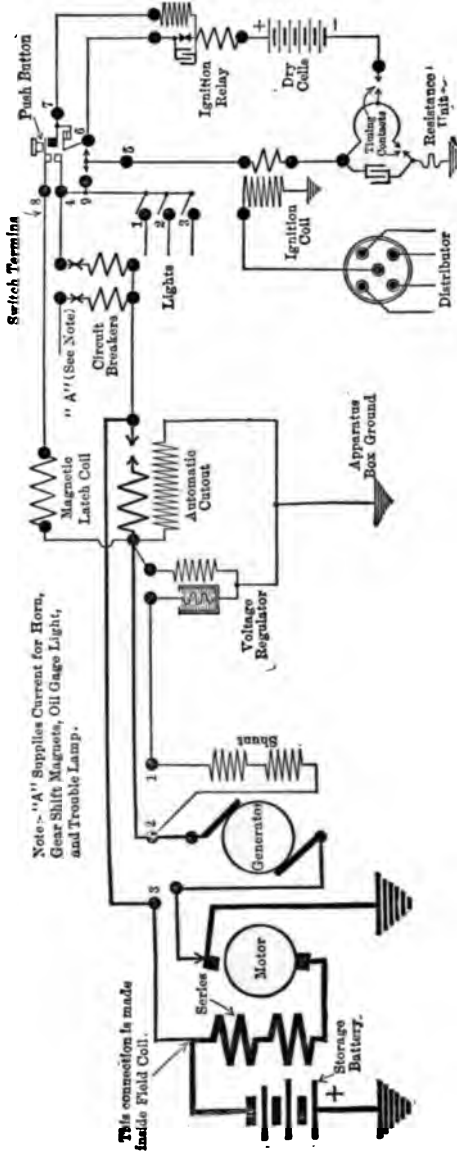

Combination Switch No. 1042.
Ignition Coil No. 2104.

Motor Generator No. 24.
Battery. Type 3-PH-13.

Cadillac. Type 53. Delco.

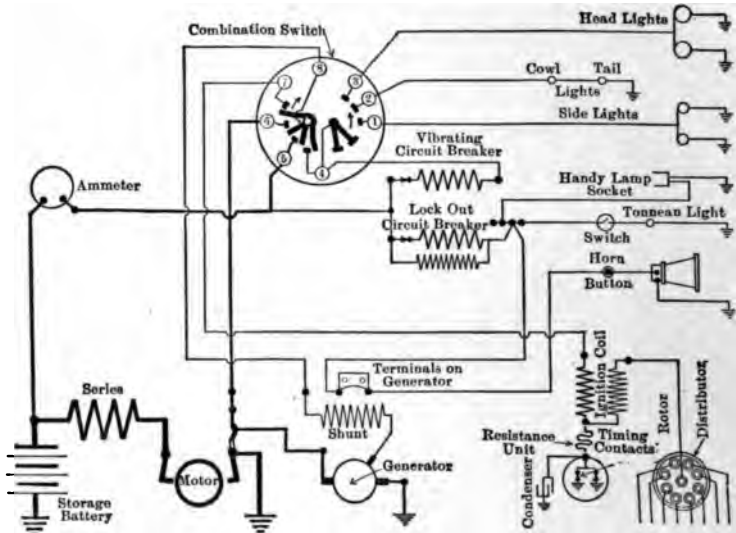

Motor Generator No. 78.
Ignition Coil No. 2115.

Combination Switch No. 1062 or
1069

Cole, 1915 Model, 6-50 Delco.

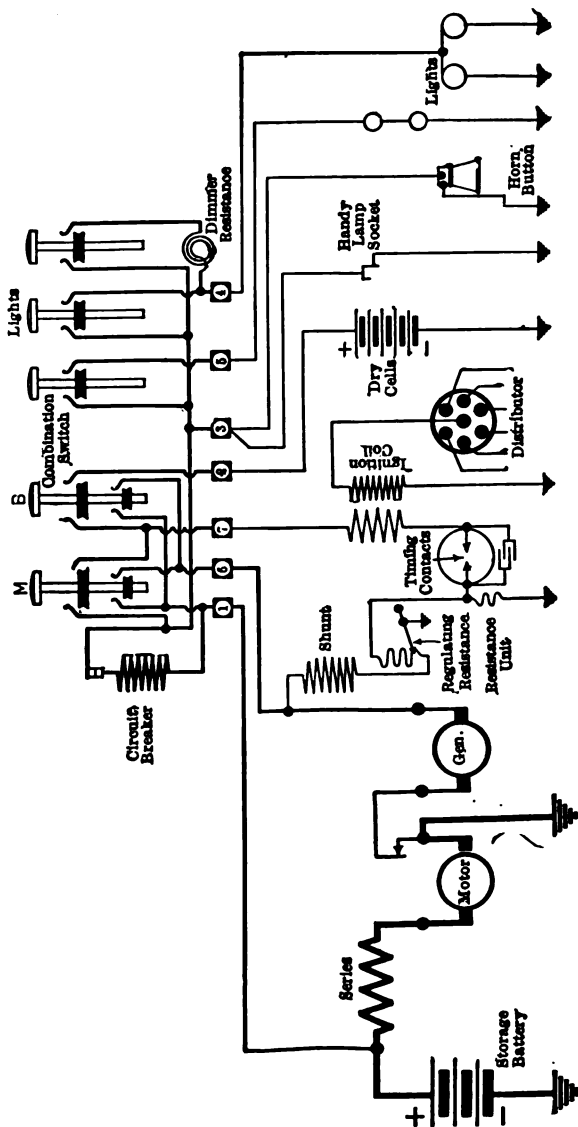

Combination Switch No. 1048.
Ignition Coil No. 2111.

Motor Generator No. 59
Battery, Type 3-X-155-1.

Cole, Model 850. Delco.

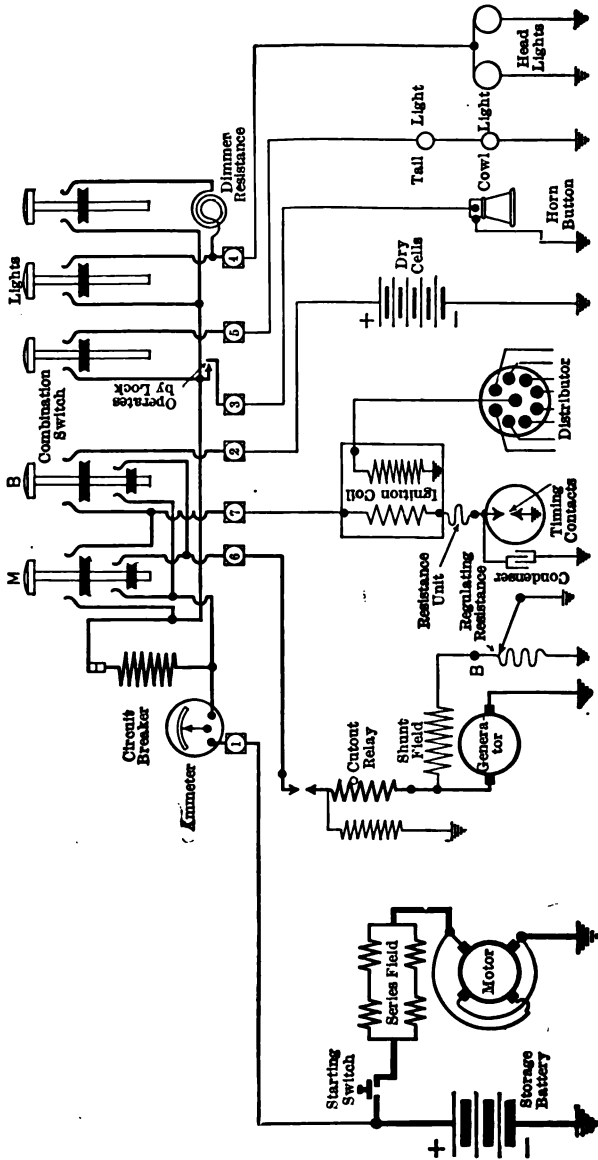

Generator No. 62.
Starting Motor No. 63.

Ignition Coil No. 2117.
Combination Switch No. 1056.

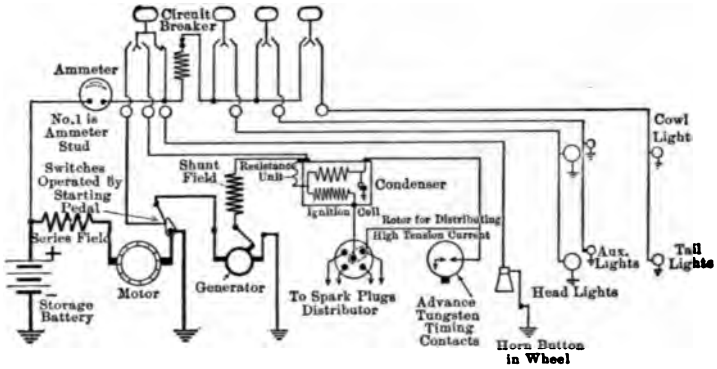

Wiring Diagram. Oakland. Model 38.

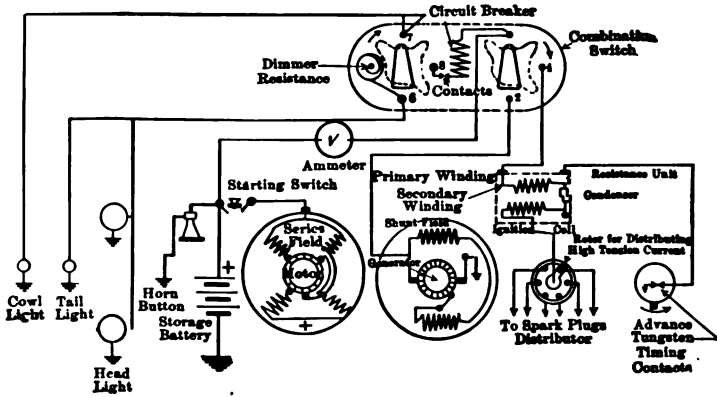

Wiring Diagram. Oakland. Model 32-B.

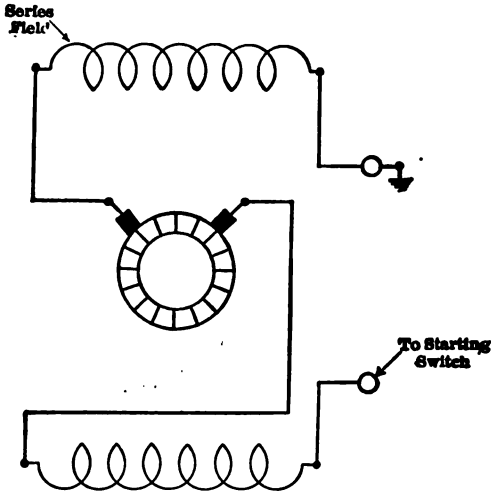

Dyneto Starting Motor. No. UAB. 6 Volts.

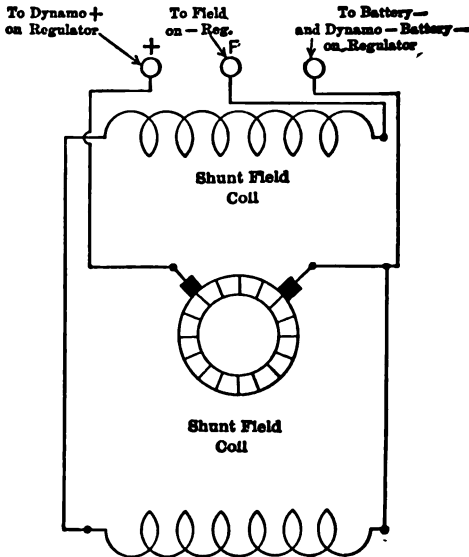

Dyneto Generator. 6 Volts.

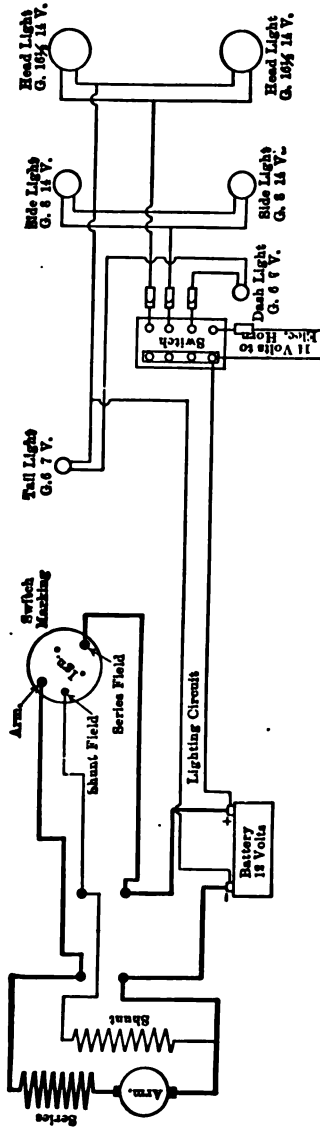

Wiring Diagram. Dyneto Electric Starting and Lighting System.

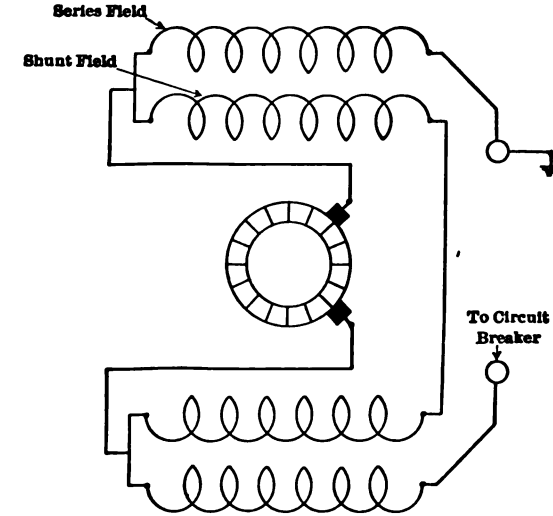

Electric Auto Lite.
Bucking Field Generator. 6 Volts.
Type G. C. and G. D.

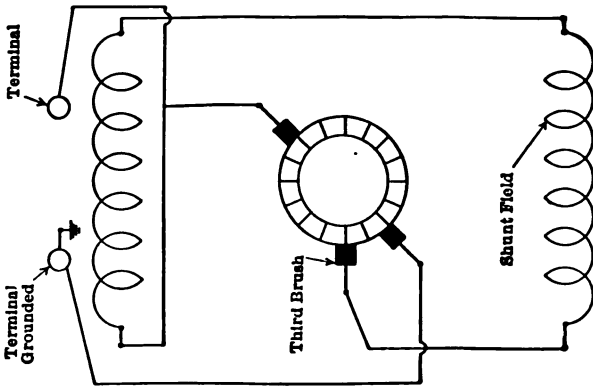

Electric Auto Lite Generator.
Type G. H. 3d Brush. 6 Volts.

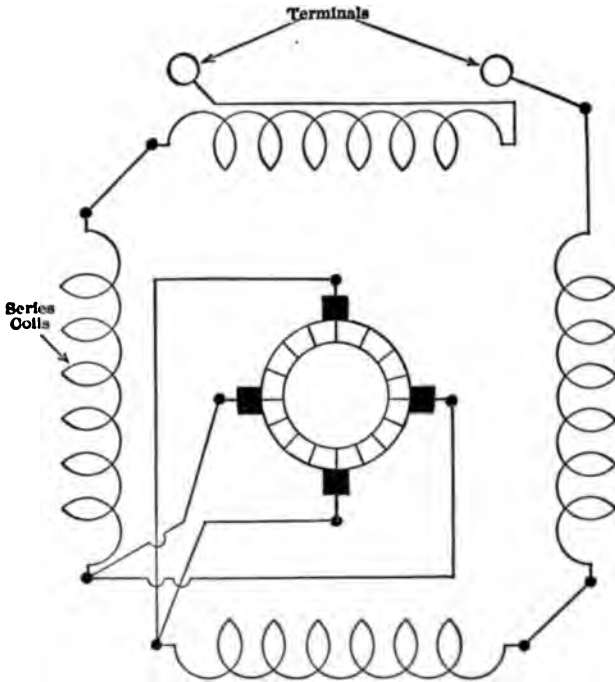

Electric Auto Lite. Starting Motor. Type M. F. 6 Volts.

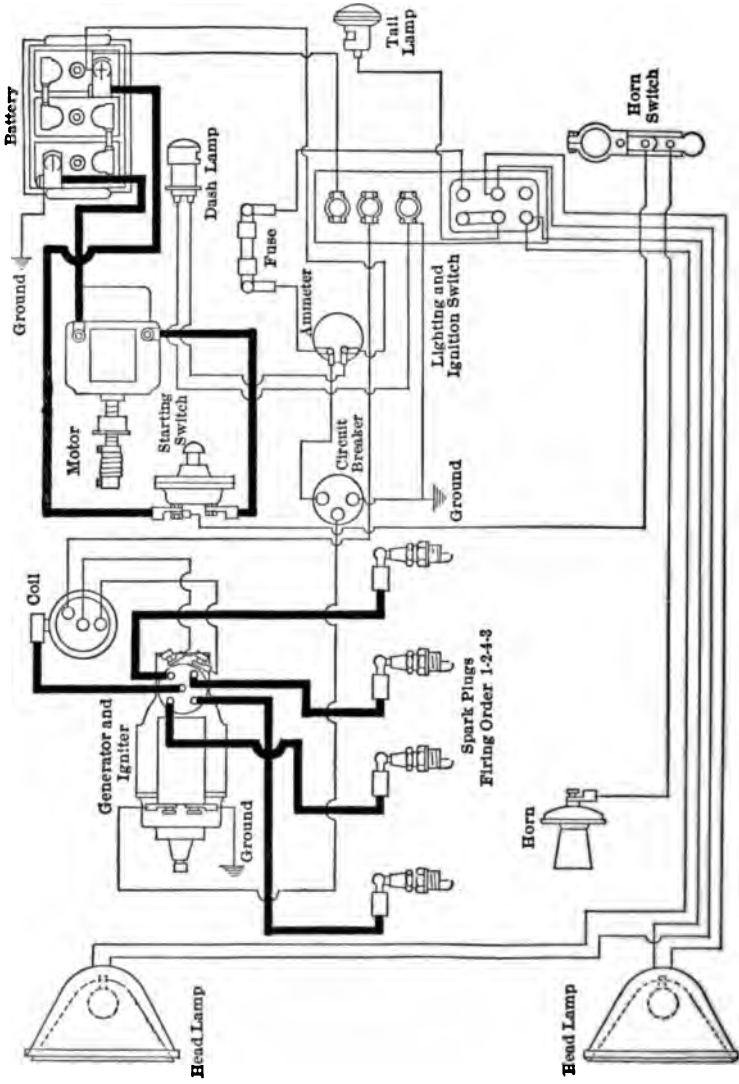

Connecticut Auto Lite.

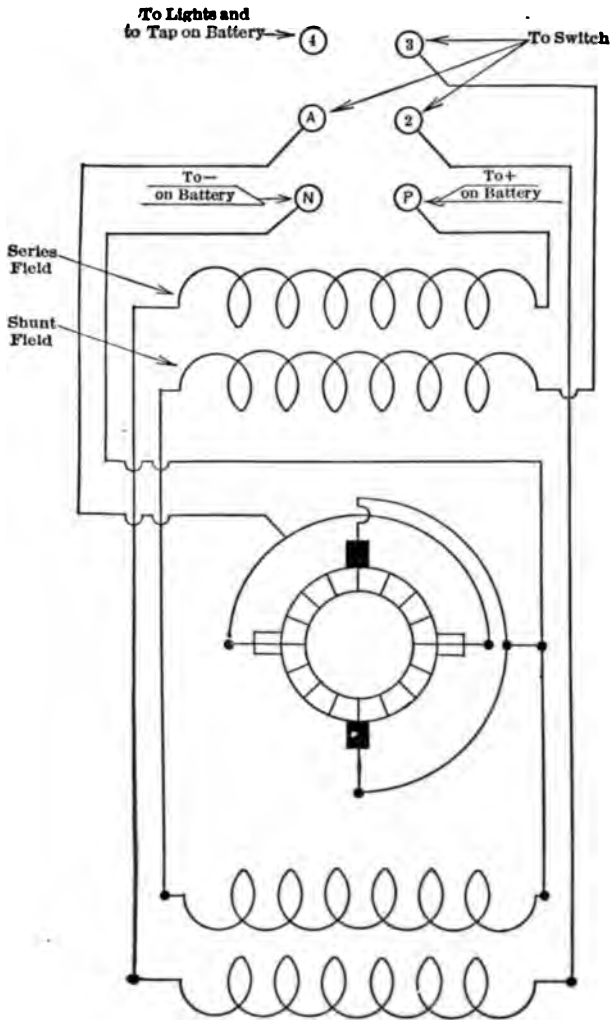

Entz Motor Generator. 18 Volts.

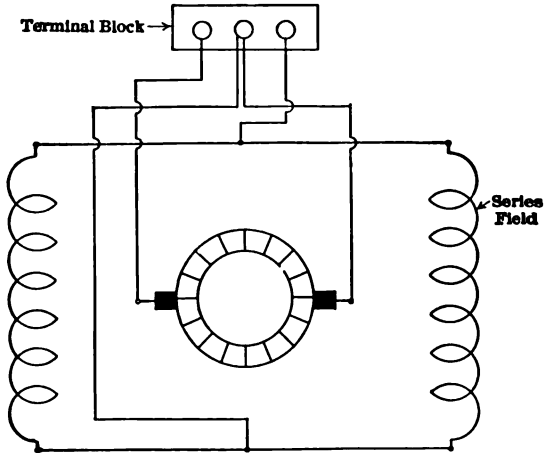

Gray & Davis Starting Motor. Type K. 6 Volts. 100 Amperes.
3600 R.P.M.

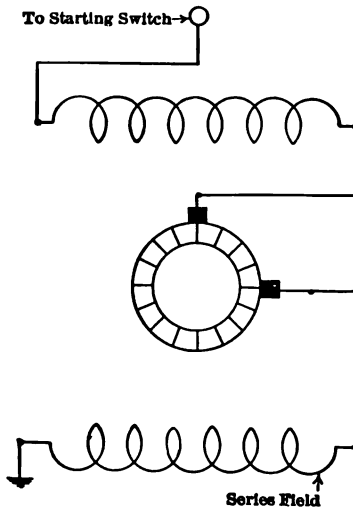

Gray & Davis Type Y Starting Motor.

DIAGRAMS

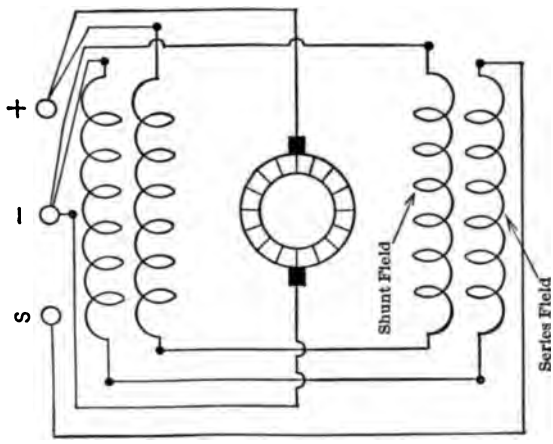

Gray & Davis
Type C1 Generator. 6 Volts.
Cutout Relay Shown on Page 144.

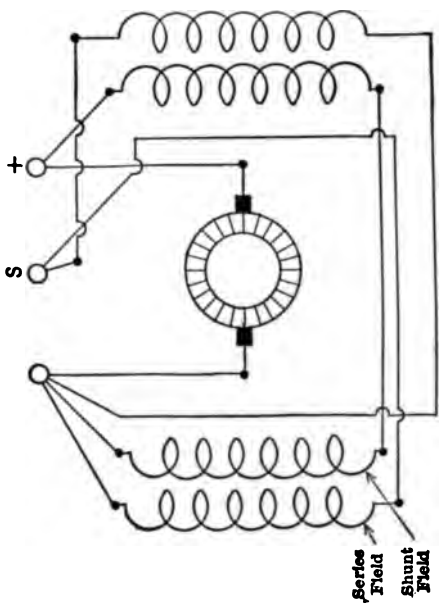

Gray & Davis.
Type G1 Generator. 6 Volts.
Cutout Relay Shown on Page 143.

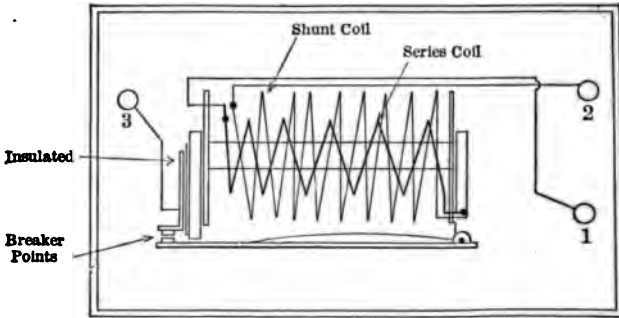

Gray & Davis Cut-out. For Type C1-G1 and E Generators. 6 Volts.

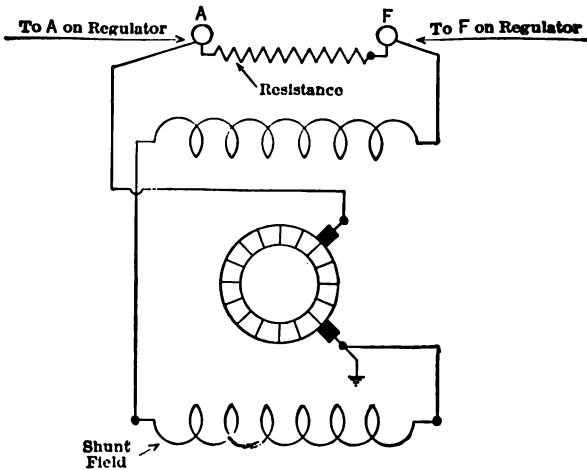

Gray & Davis Type 240 Generator. 6 Volts. Regulator shown on Page 145.

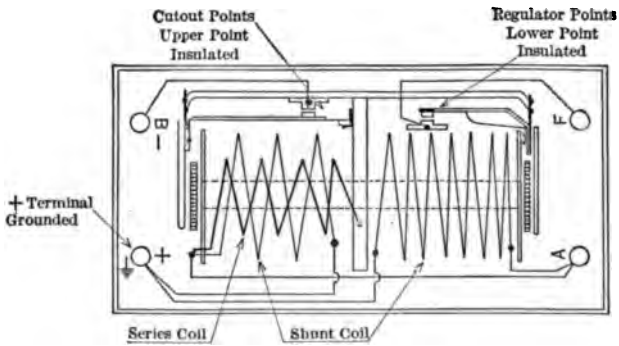

Gray & Davis Regulator and Cut-out for Type 240 Generator. 6 Volts.

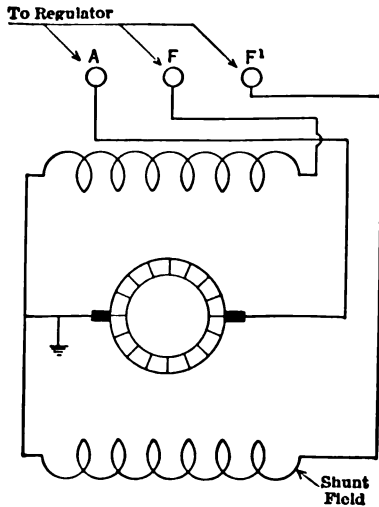

Gray & Davis Type T Generator. 6.5 Volts. 10 Amperes. Regulator shown on Page 147.

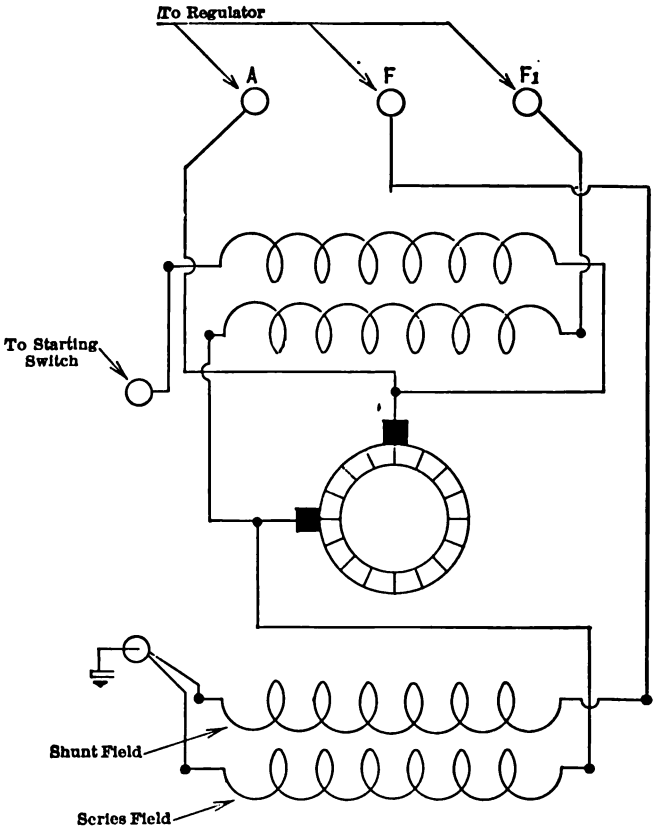

Gray & Davis Type M. G. 9 Motor Generator. 6 Volts. Regulator shown on Page 147.

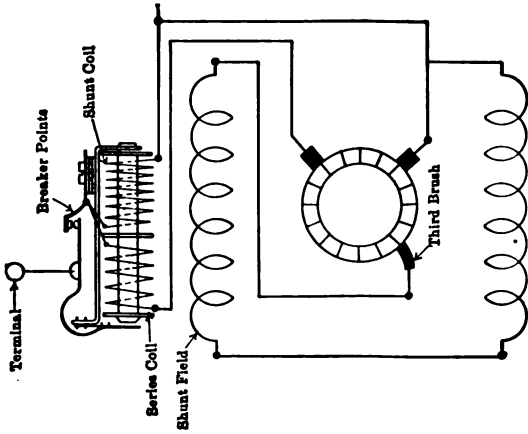

Gray & Davis
3d Brush Generator.

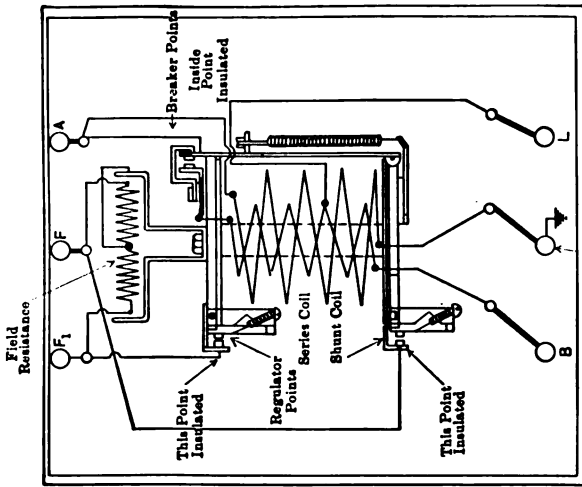

Gray & Davis Cutout and Regulator.
For Generator Types T220-221-222 and M. G. 9.
6 Volts.

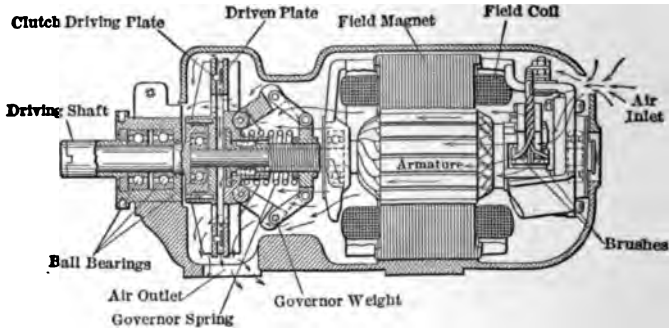

Gray & Davis Generator. Output prevented from rising above a pre-determined point by use of centrifugal governor, limiting speed of armature. Now obsolete. Field is "compounded."

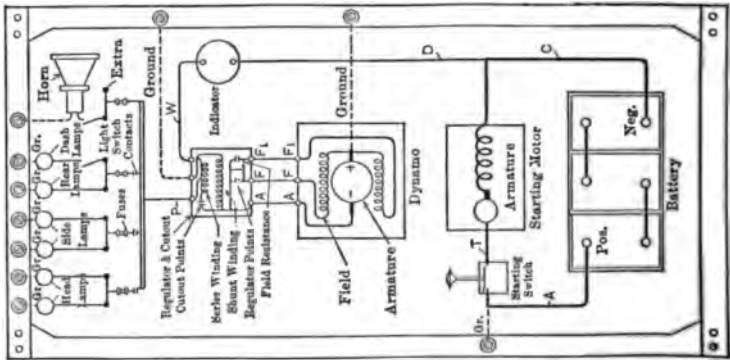

Technical Wiring Diagram with Grounded Switch.
Gray & Davis.

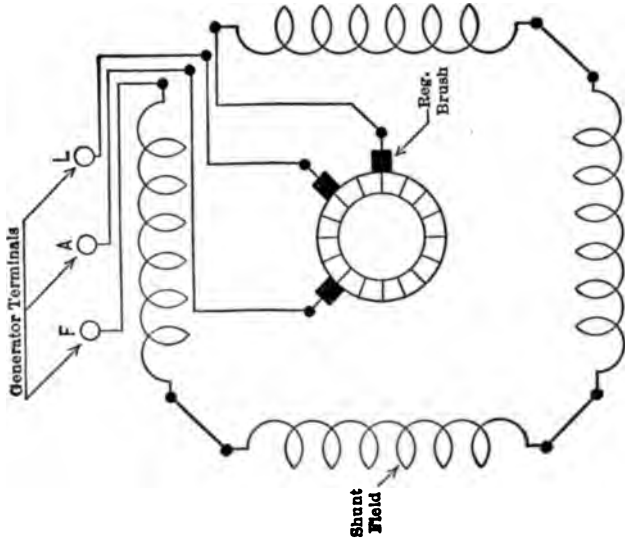

Leece Neville Generator. 6 Volts.

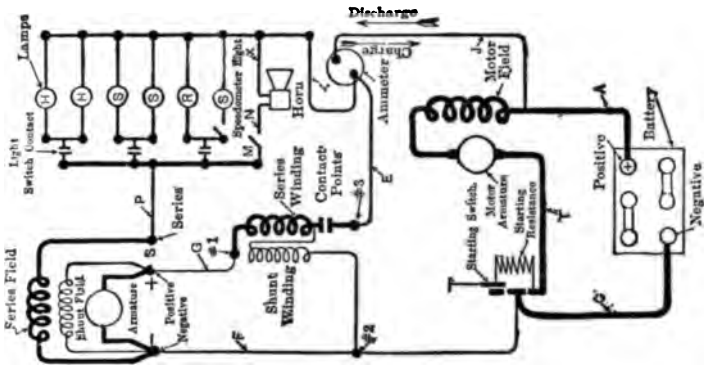

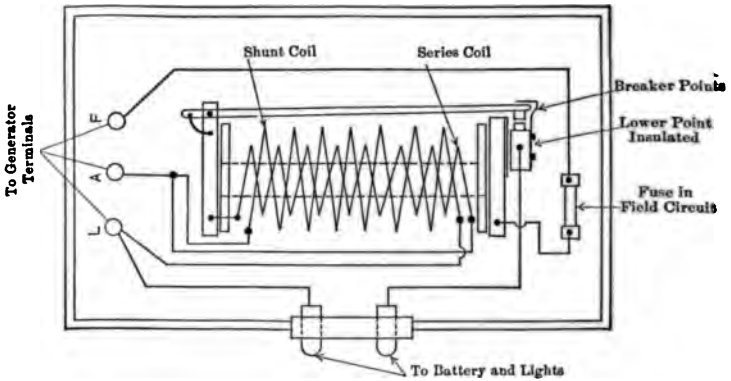

Leece Neville Cutout. 6 Volts.

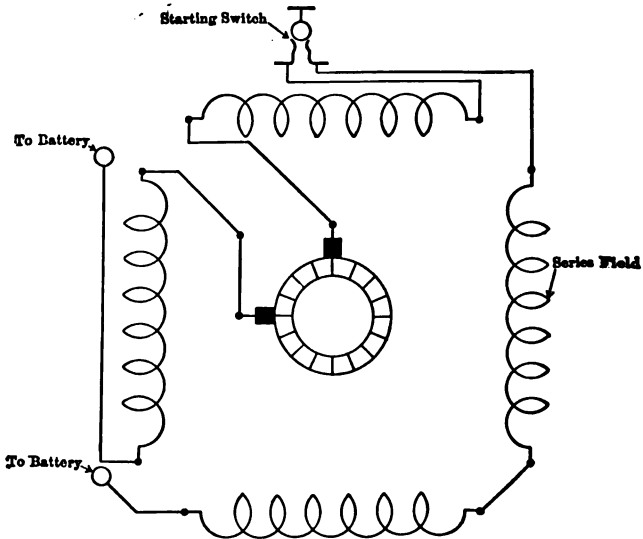

Leece Neville Starting Motor. 6 Volts.

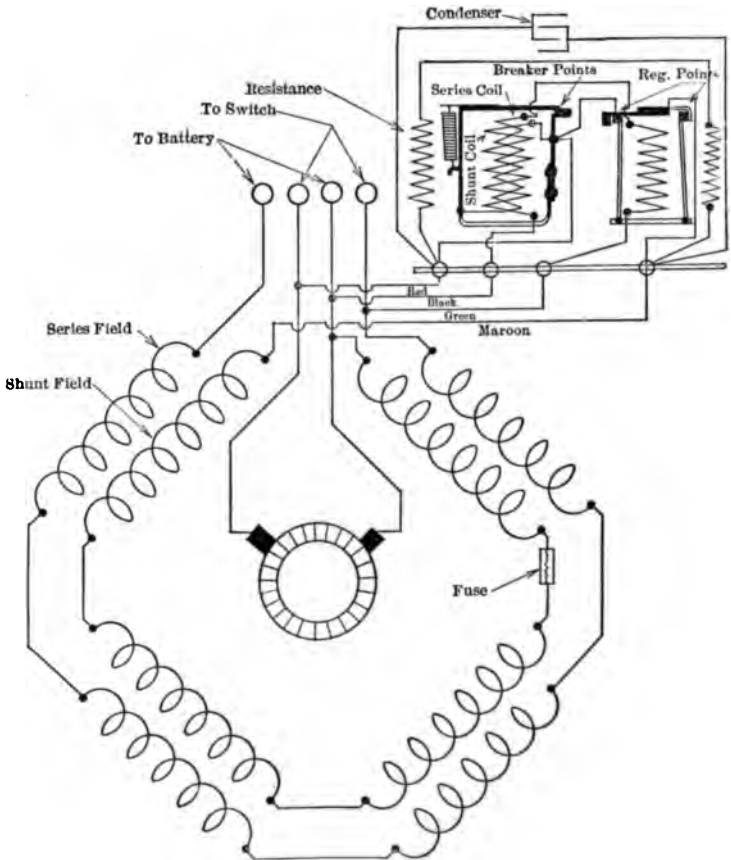

North-East Motor Generator. 24 Volts.

North-East Motor Generator. 12 Volts.

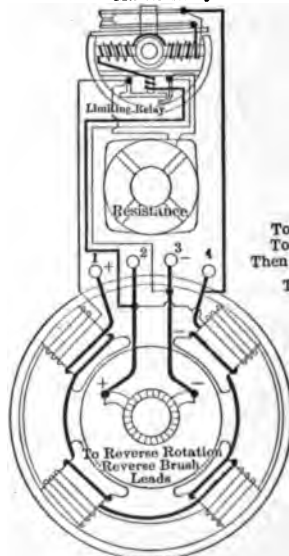
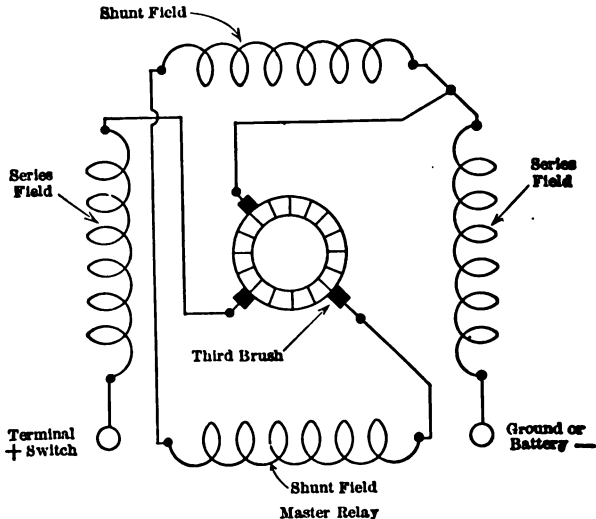

To Starting Switch
 To Lighting Switch
 Then to Starting Switch
 To Battery

North-East Internal Wiring Diagram for Original Model "A" Motor Generator.

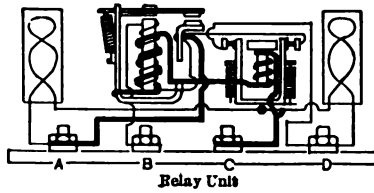
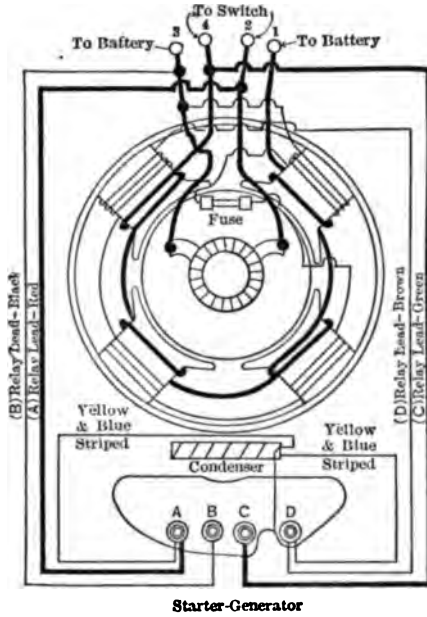

North-East Internal Wiring Diagram. Model "D" Starter-Generators. Model "F" Starter-Generators. Binding Post Terminals.

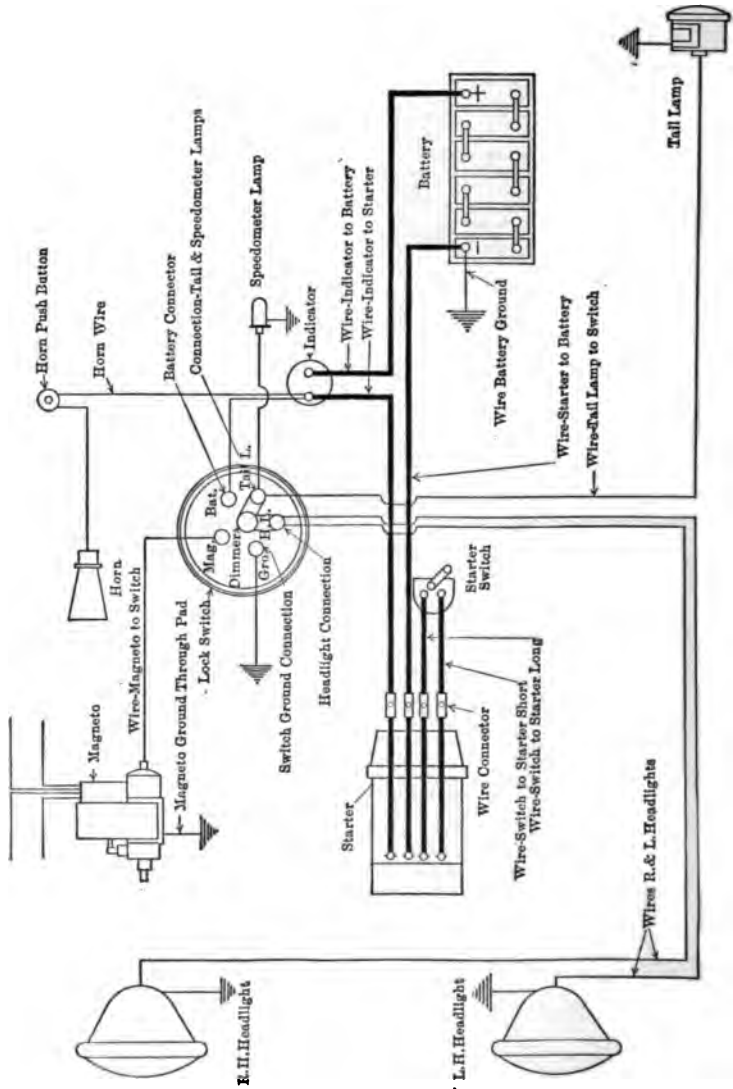

Dodge Brothers Wiring Diagram. North-East System.

DIAGRAMS

1

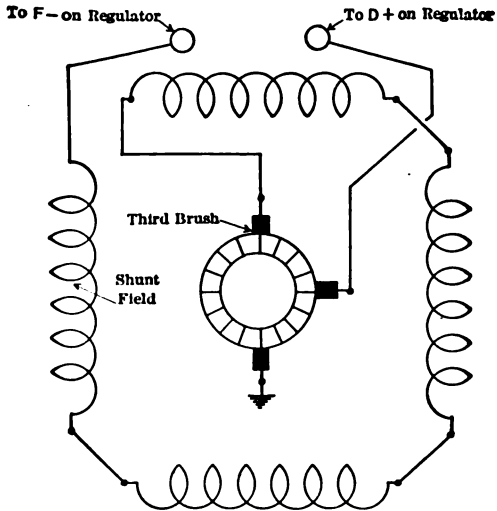

Remy Generator. Model 168-E. 6 Volts.

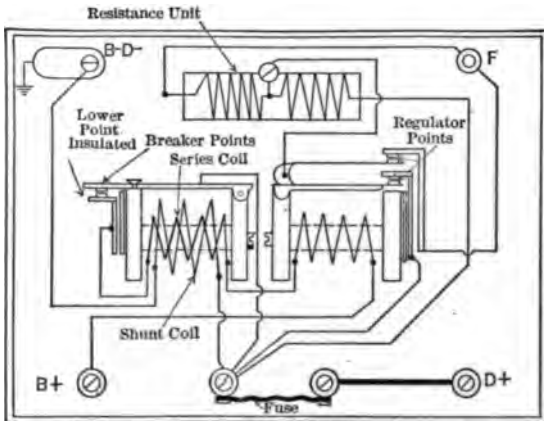

Remy Cutout and Regulator. Model 60-A. 6 Volts.

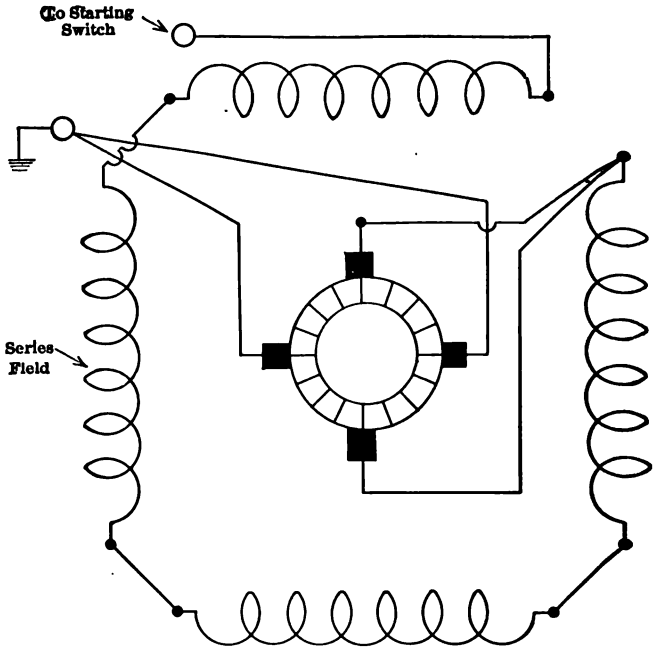

Remy Starting Motor. Model 117. 6 Volts.

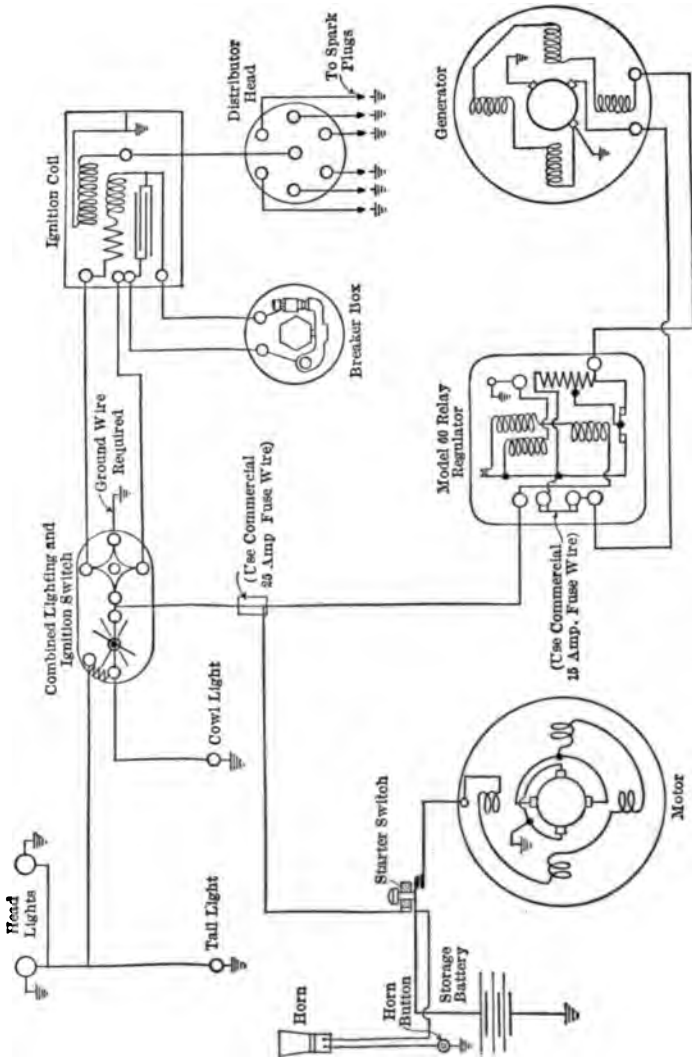

Remy Electric Company, Anderson, Ind. Wiring Diagram for Oakland Model 32.

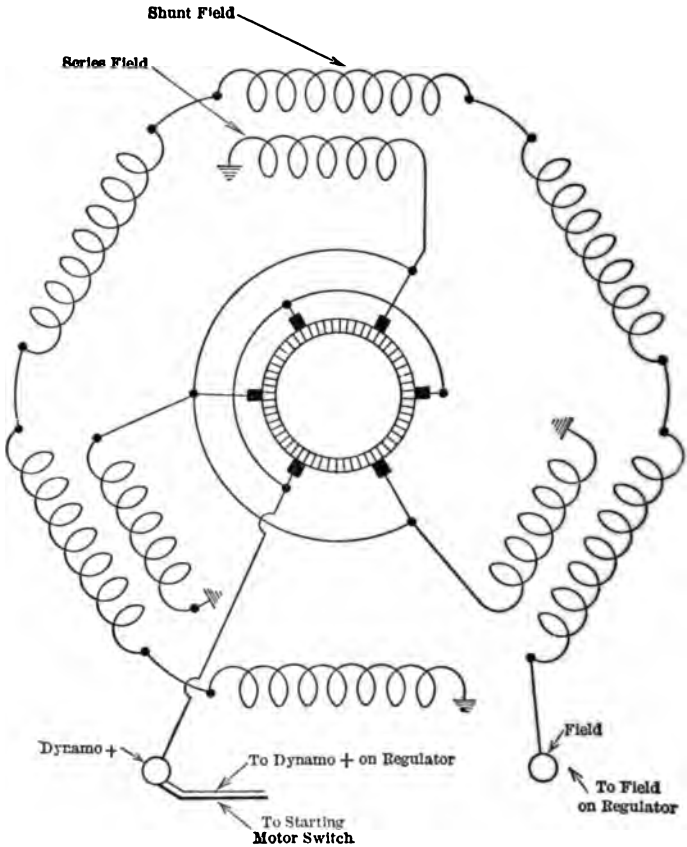

Simms-Huff Internal Connections. Lighting Generator and Starting Motor. Gen. 6 Volts. Motor 12 Volts.

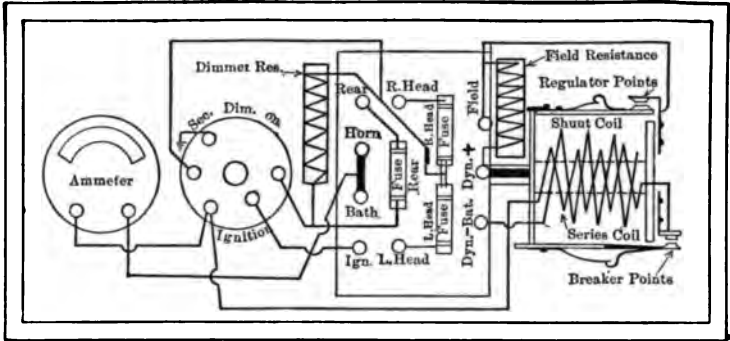

Dash Panel. Switch, Ammeter, Regulator. For Simms-Huff Generator. Generator Diagram Page 158.

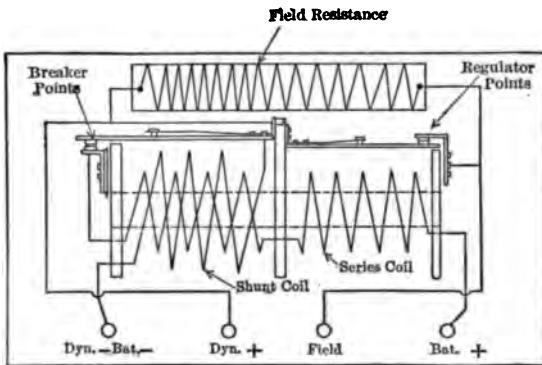

Dynamo Regulator. Reverse Current Cutout. Briggs & Stratton Co. 6 Volts. 12 Amperes. For Simms-Huff Generator. Generator Diagram Page 158.

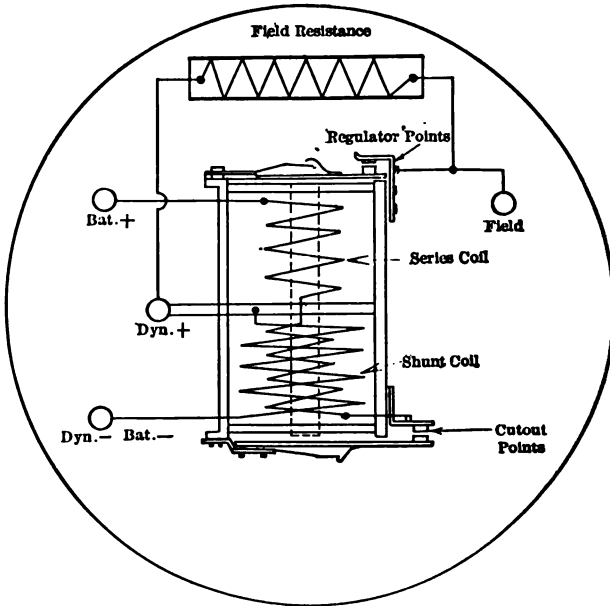

Regulator and Cutout. 6 Volts. Ohms. Used with the **Simms-Huff** Generator, Diagram Page 158.

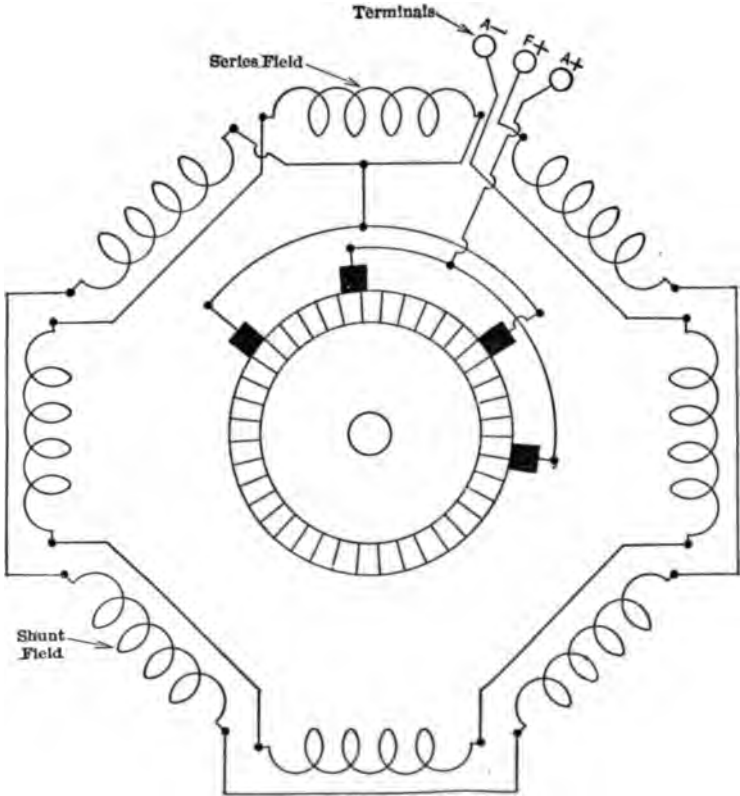

U. S. L. Motor Generator. Starting Volts 12. Generator Voltage 6.

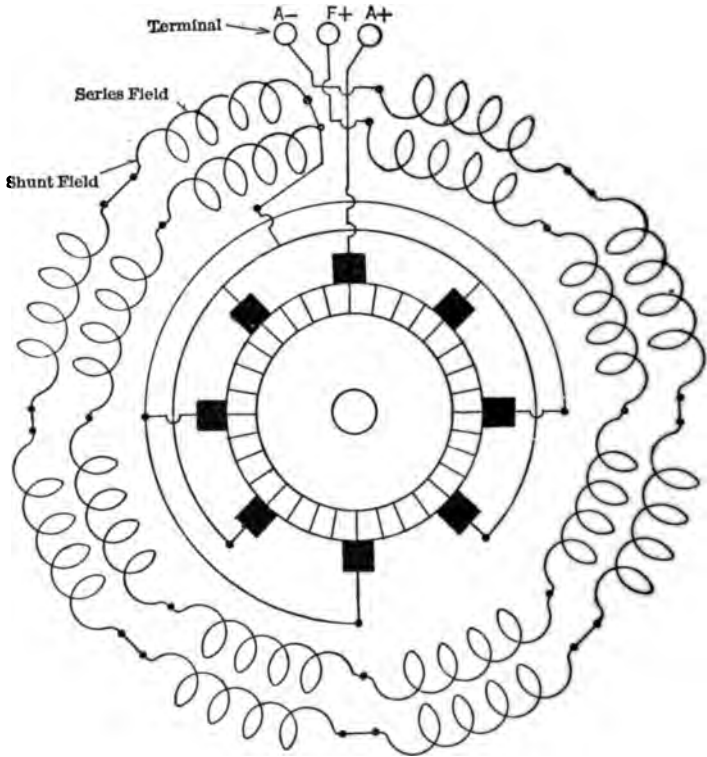

U. S. L. Motor Generator. Starting Volts 24. Generator Voltage 12.

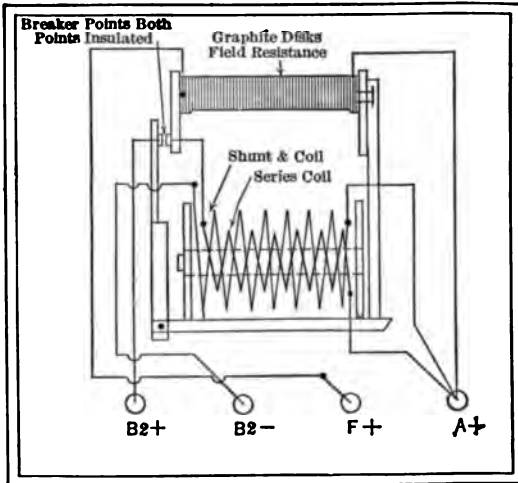

U. S. L. Cut-out and Regulator.

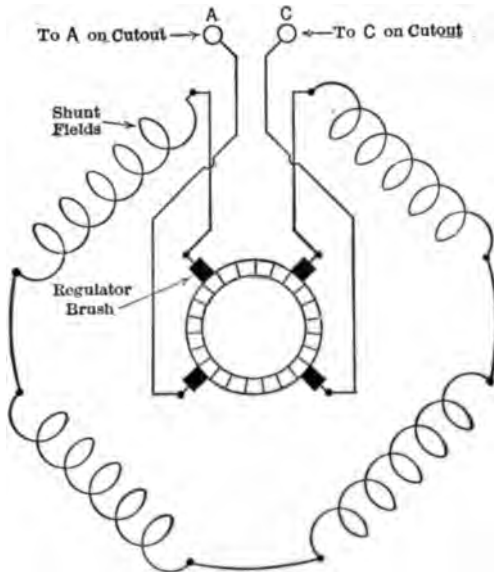

Wagner Direct-current Generator. 6 Volts. Spec. No. E. M. 107.
Internal Connections. Cut-out Diagram Page 164.

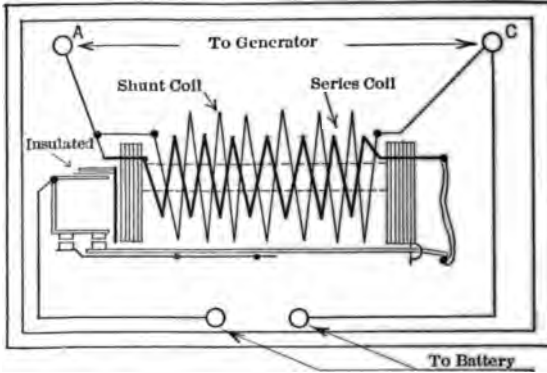

Wagner Cut-out. For Direct-current Generator. 6 Volts. Spec. No. E. M. 107. Generator Diagram Page 163.

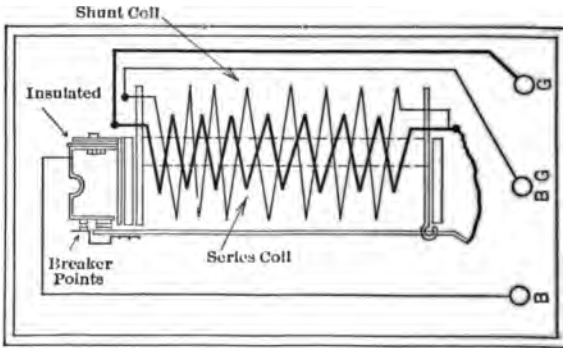

Wagner Cut-out. For Separate Mounting. No. Spec. E. M. 107. 6 Volts.

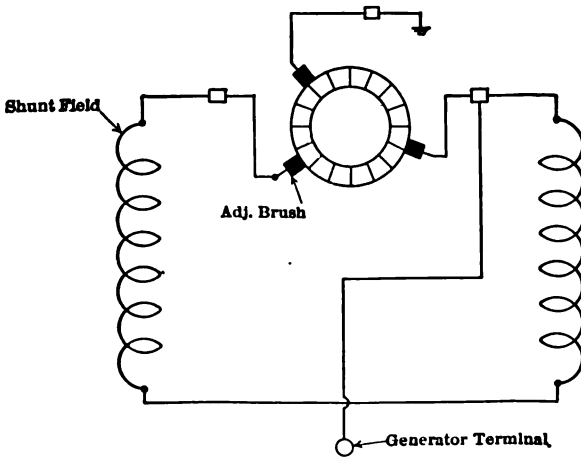

Wagner Generator. Spec. E. M. 6 Volts.

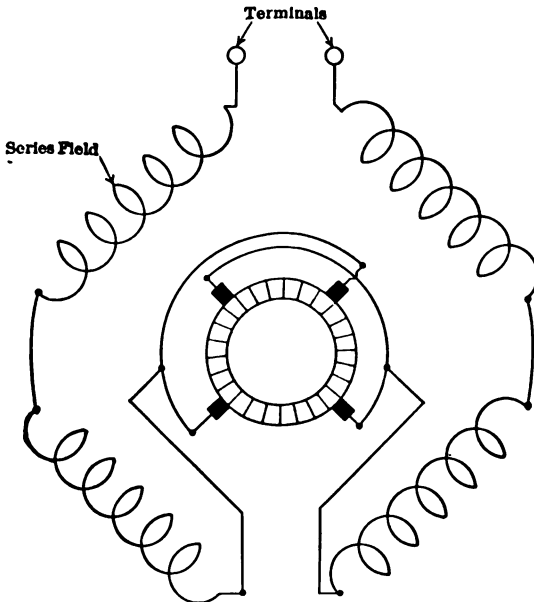

Wagner Direct-current Starting Motor. 6 Volts. Special No. E. M. 106. Internal Connections.

Remy Electric Company, Anderson, Ind. Circuit Wiring Diagram on 1916 Studebaker.

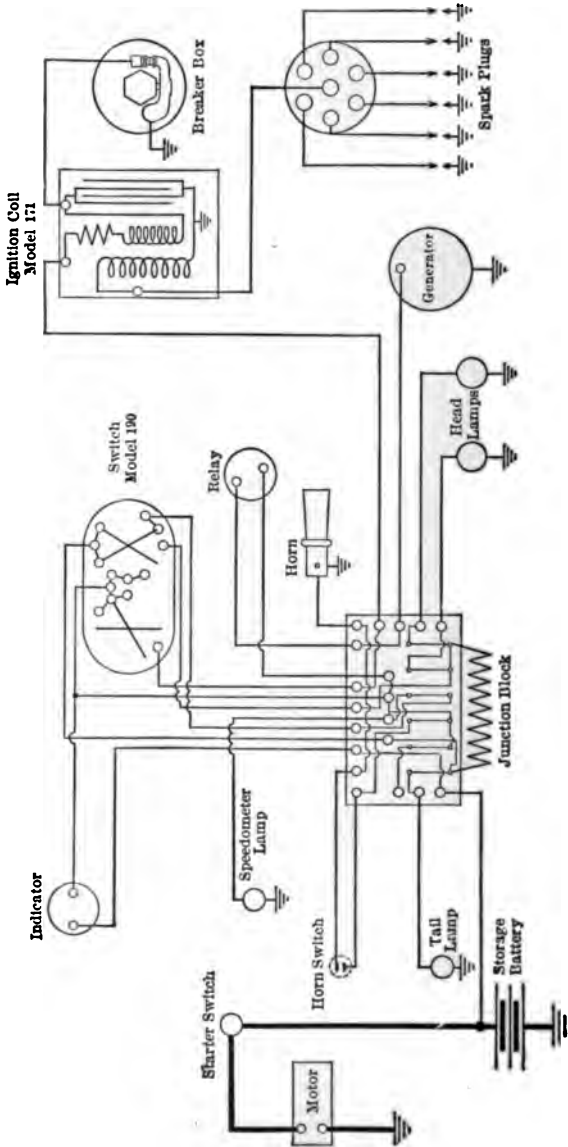

Wagner Generator and Starting Motor Employed on this Model of Studebaker Car.

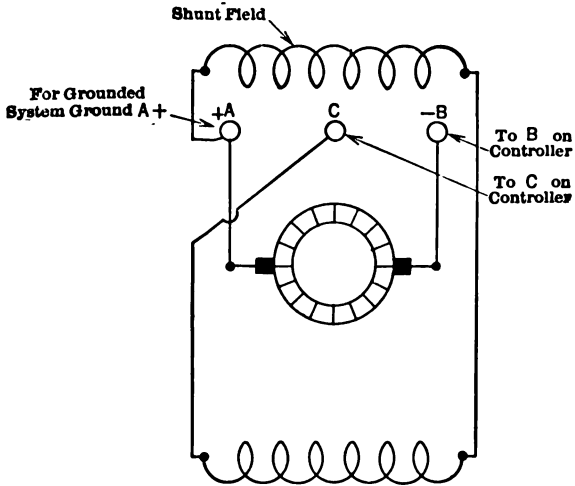

Ward-Leonard Electrical Co. Generator. 10 Amperes. 6 Volts.

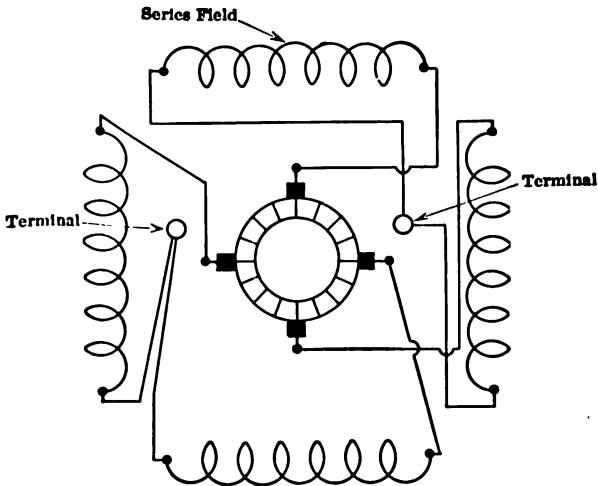

Ward-Leonard Electrical Co. Starting Motor. 6 Volts.

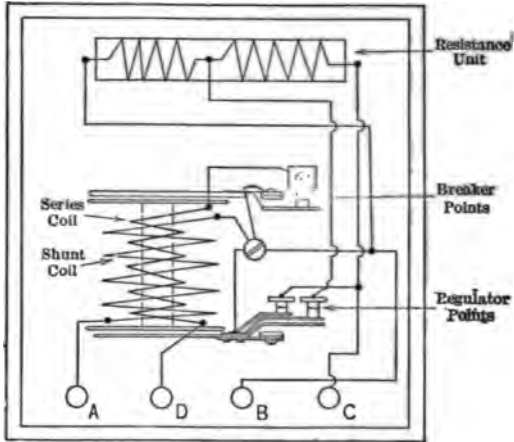

Ward-Leonard Automatic Controller. Type CC and DD.

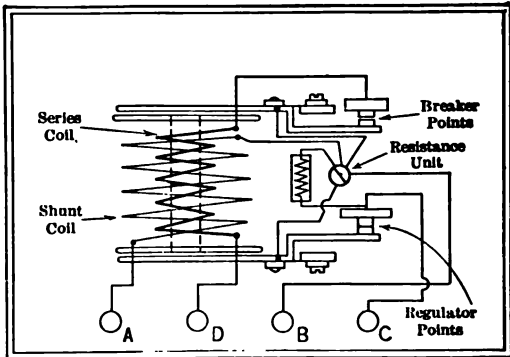

Ward-Leonard Automatic Controller. Type CC 325.

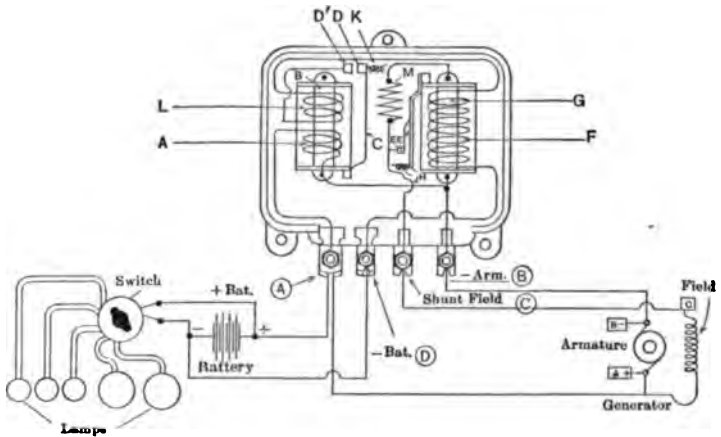

Type E Controller. Ward-Leonard Circuit Diagram.

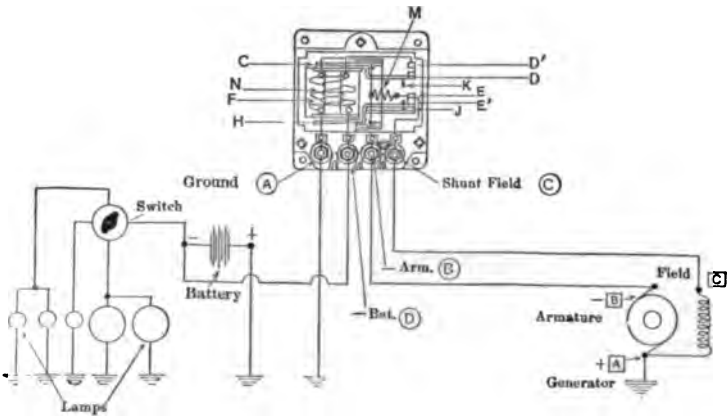

Wiring Diagram of Ward-Leonard "CC" Type Controller.

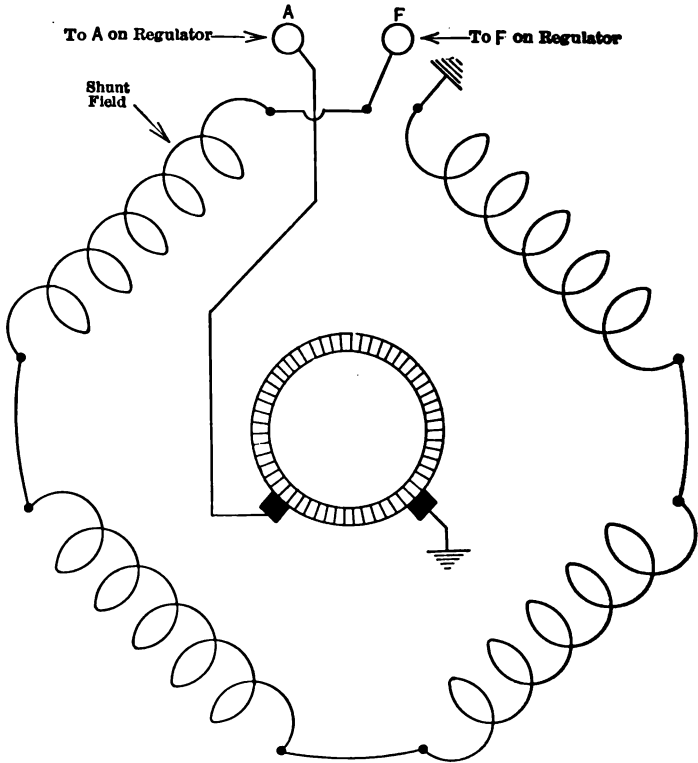

Westinghouse No. 400 Generator Frame. Internal Connections and Cutout. Uses Separate Regulator. 6 Volts.

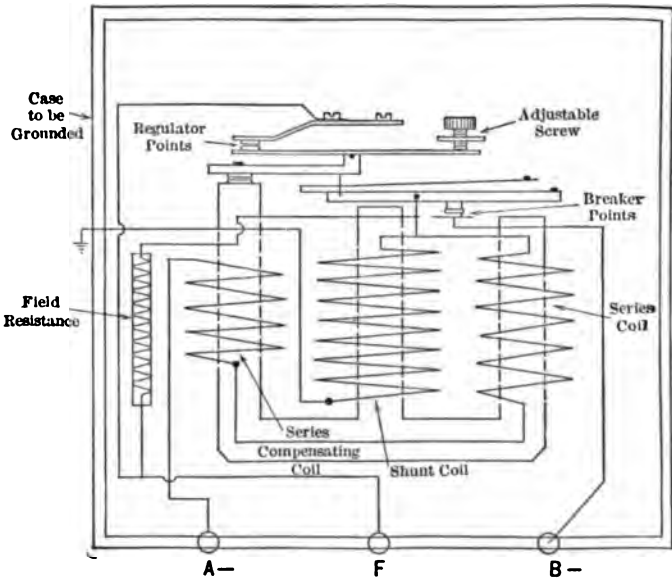

Westinghouse Voltage Regulator and Cutout. Used with No. 400 Generator. 6 Volts.

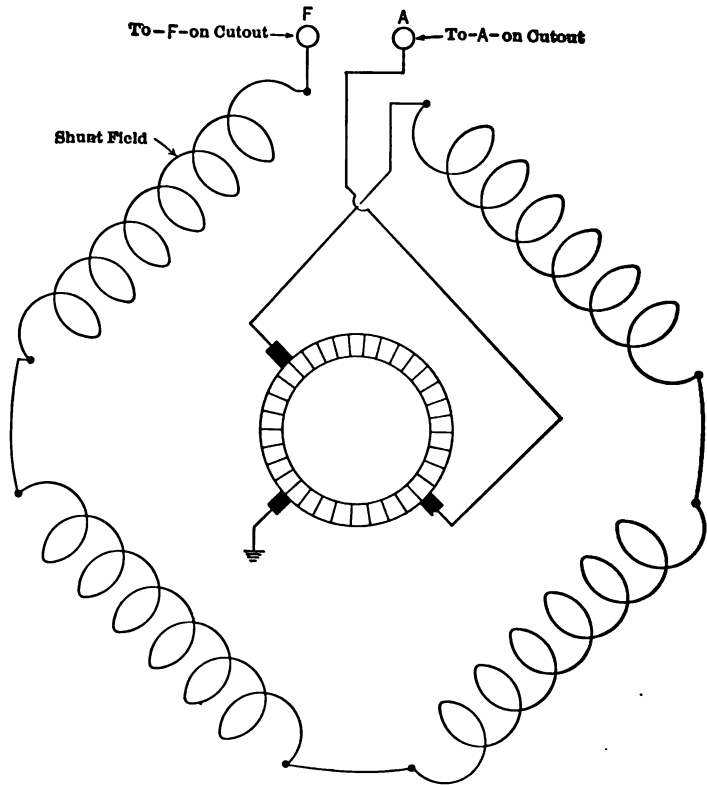

Westinghouse No. 450 Generator Frame. Internal Connections with 3d Brush Voltage. Control 6 Volts. Cutout Diagram Page 173.

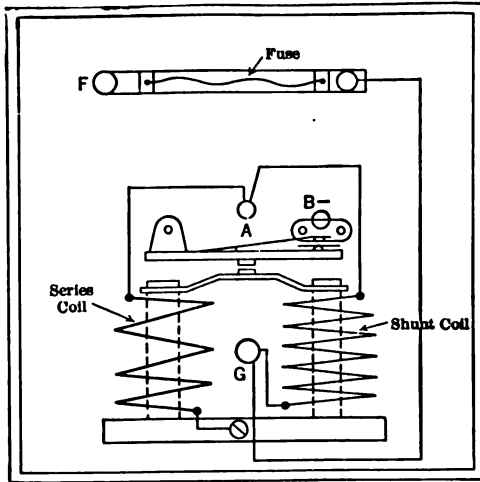

Westinghouse Cutout. 6 Volts. For Frame 450. 3d Brush Generator.

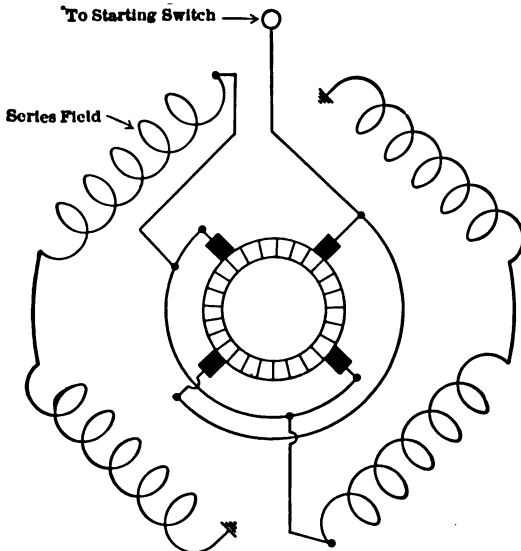

Westinghouse Starting Motor Frame No. 700 with Bendix Drive.
Internal Connections. 6 Volts.

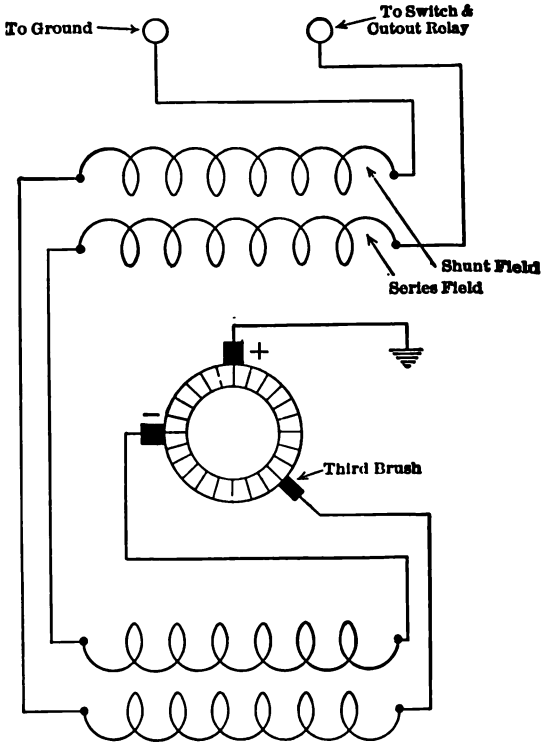

Westinghouse Motor Generator, Frame 600. 12 Volts.

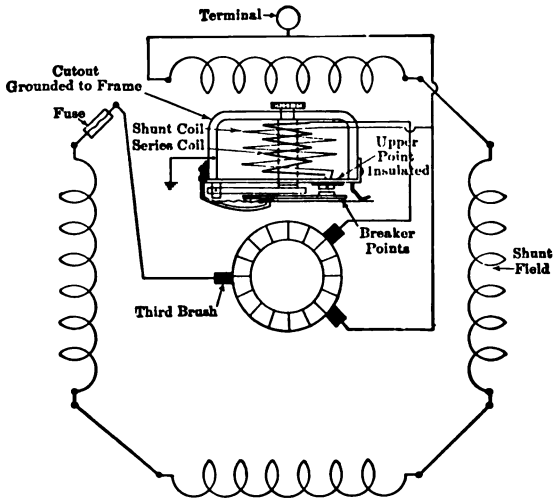

Westinghouse 3d Brush Generator. 6 Volts.

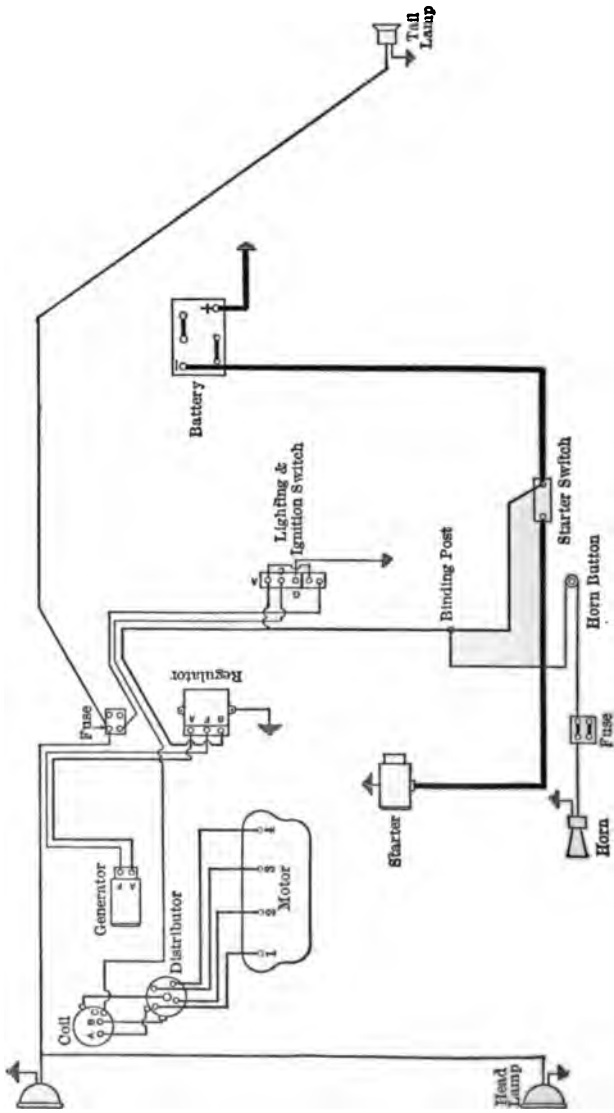

Dort Model 5. Westinghouse. Connecticut.

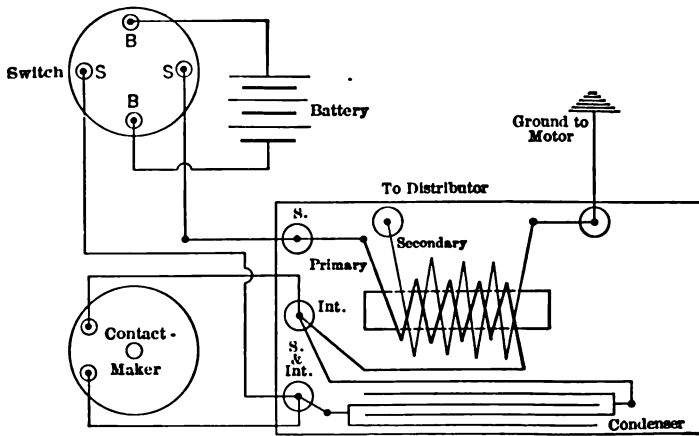

Atwater-Kent Coil, Type "K-2."

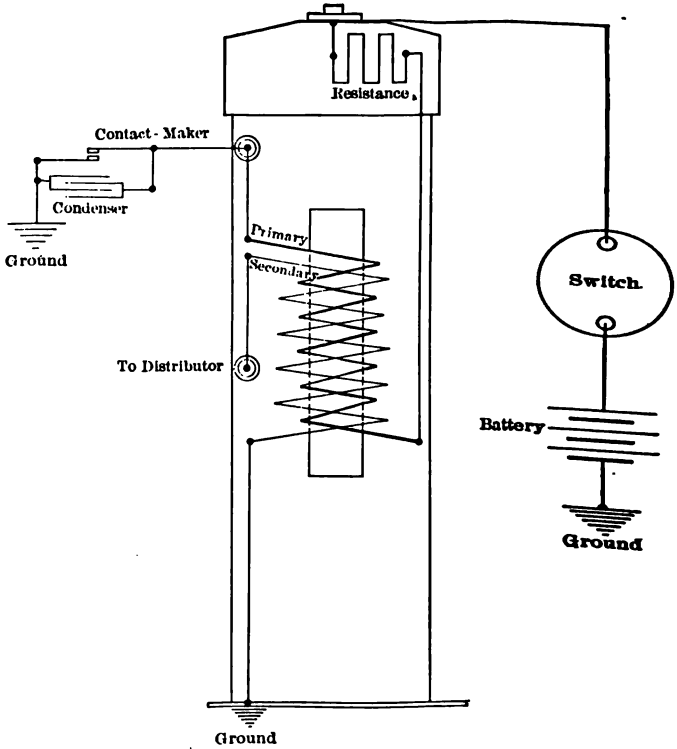

Atwater-Kent Coil, Type "CC."

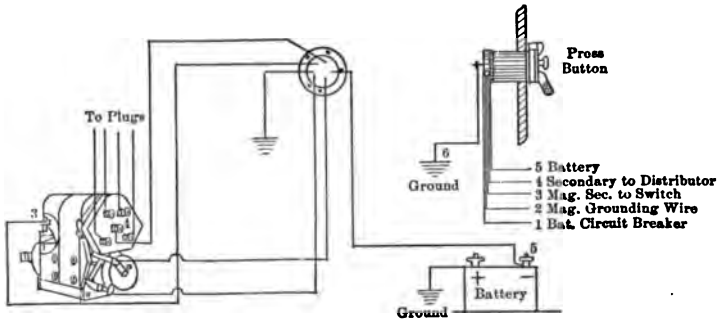

Bosch Magneto, DU 4, Dual System.

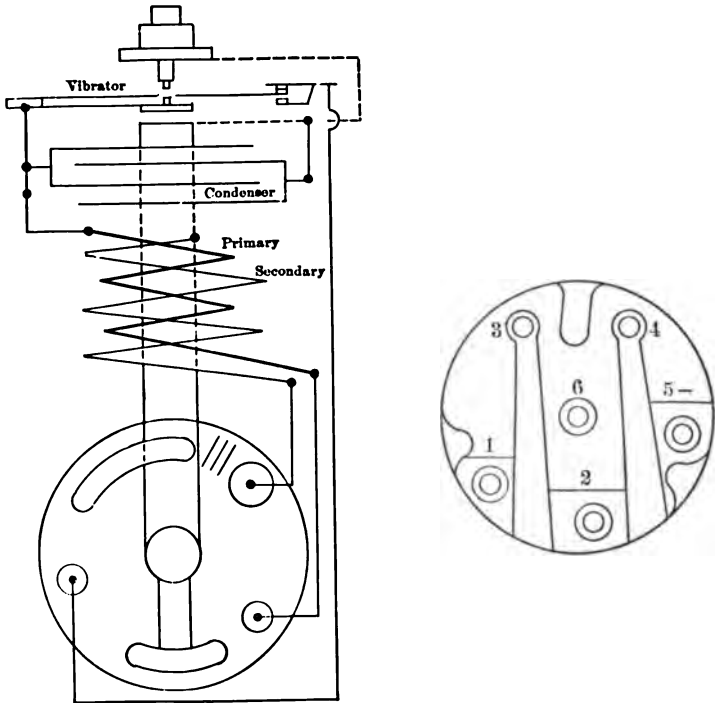

Bosch Dual Coil.

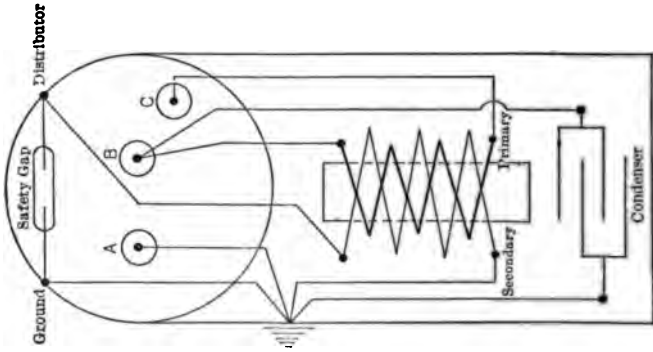

Connecticut Coil. Type GO and GA.

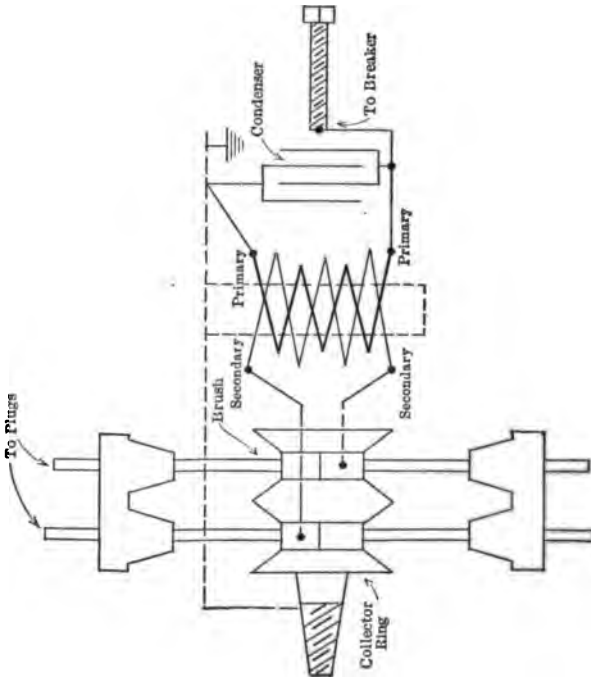

Bosch High-tension Magneto Armature with Collector Ring Distributer

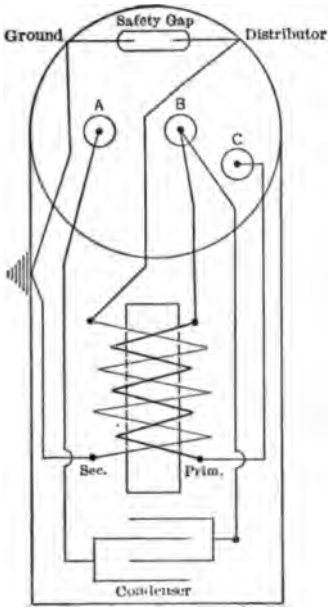

Connecticut Coil. Type GOM.

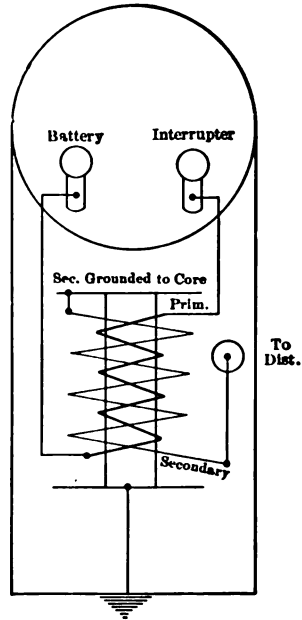

Delco Coil.

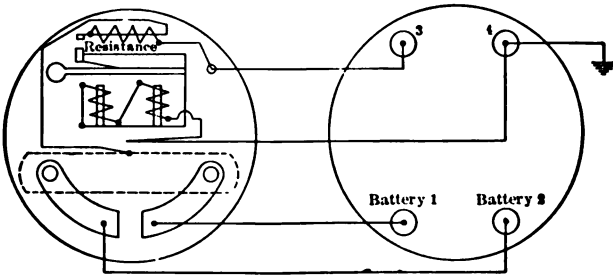

Connecticut Switch. Type G.

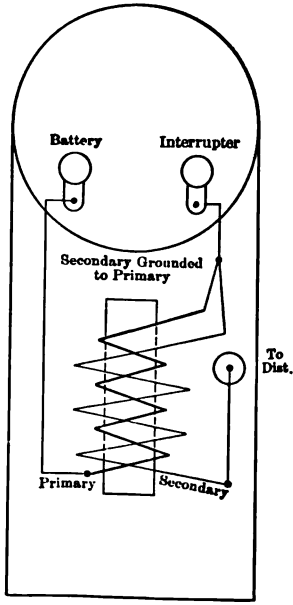

Delco Coil.

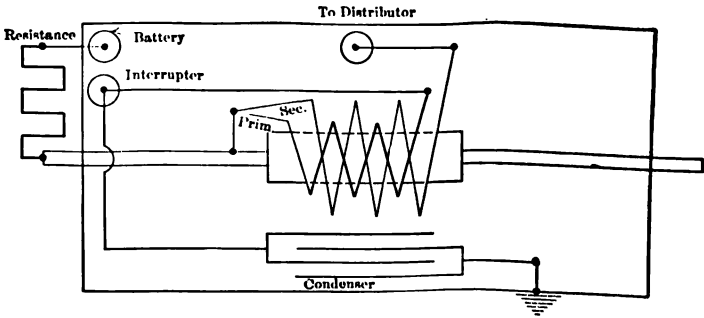

Delco Coil.

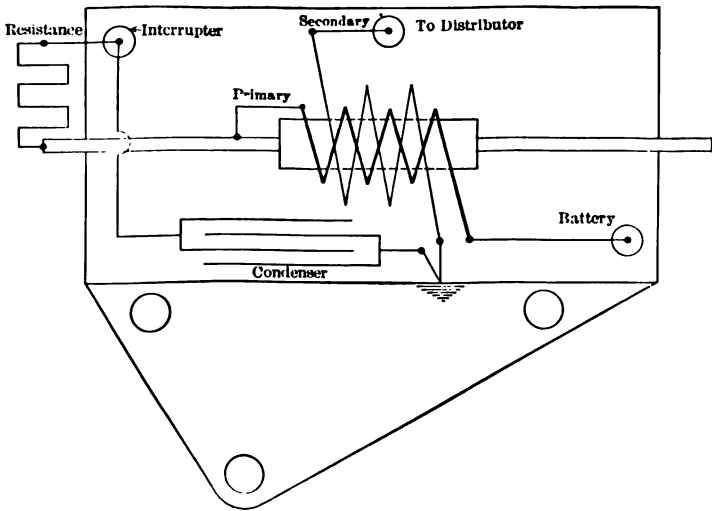

Delco Coil.

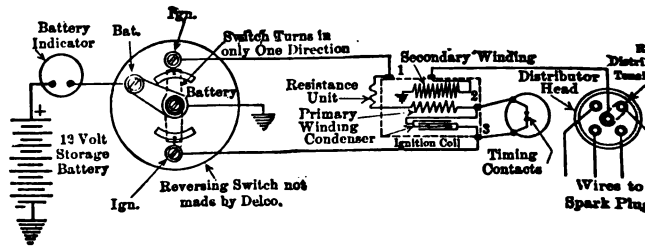

Dodge Circuit Diagram. Delco.

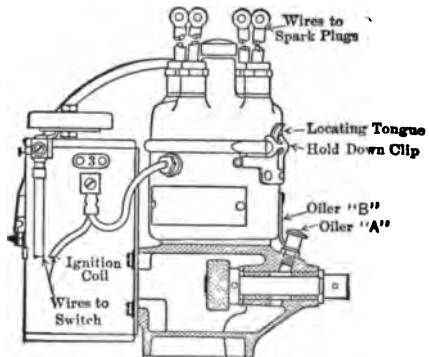

Delco-Dodge Distributer.

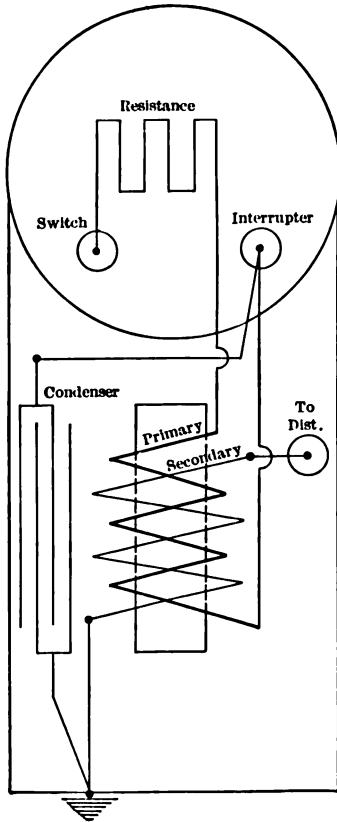

Remy Coil.

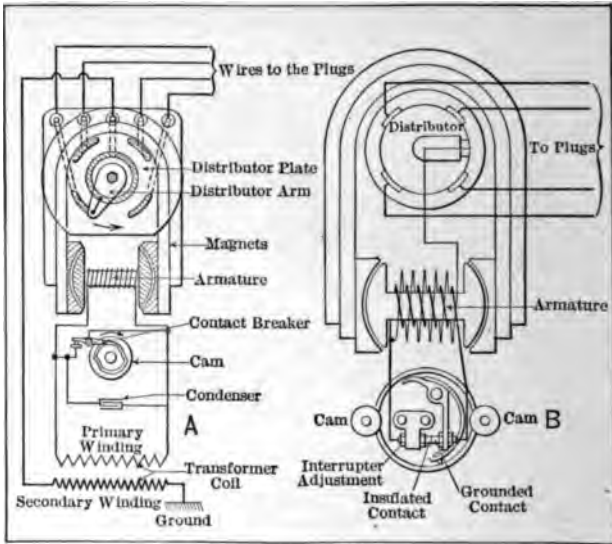

**Internal Circuit.
Low-tension Magneto.**

**Internal Circuit "Straight."
High-tension Magneto.**

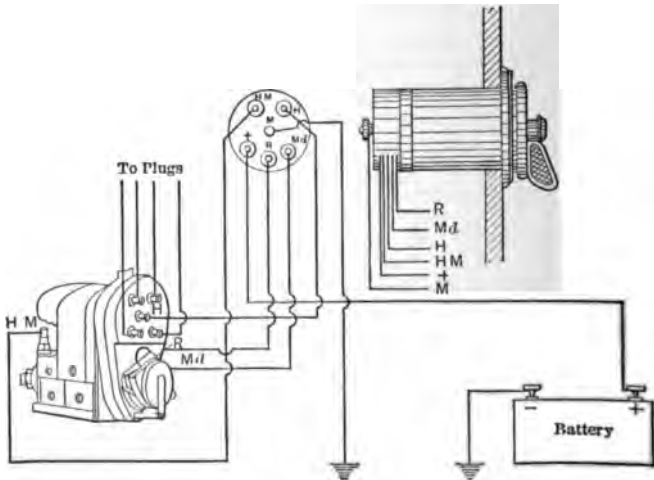

Eisemann Magneto. Type FM 4 Dual and DC Coil.

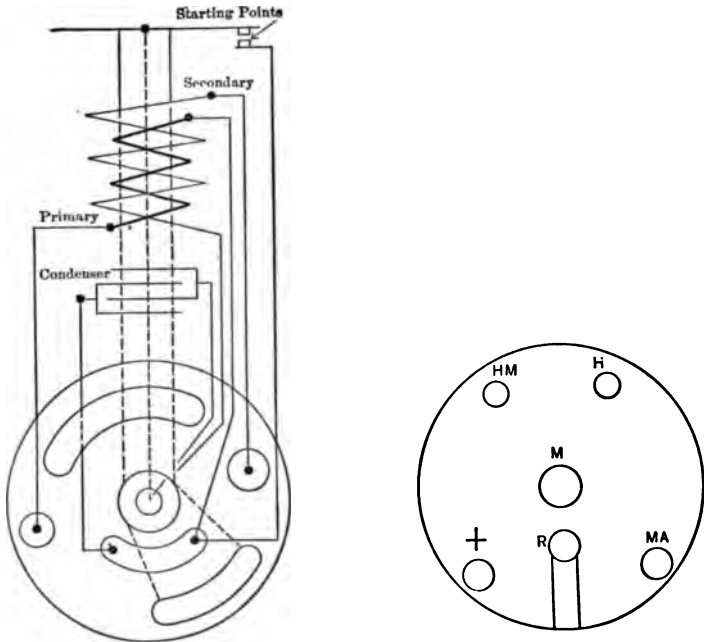

Eisemann Coil, Type D. C.

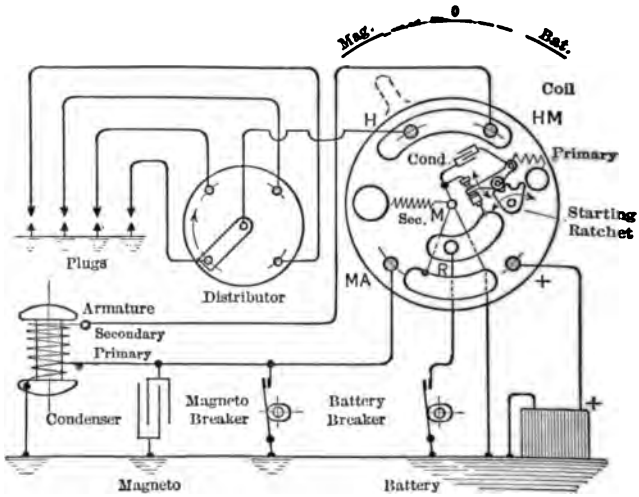

Eisemann H. T. Dual System. Magneto Position.

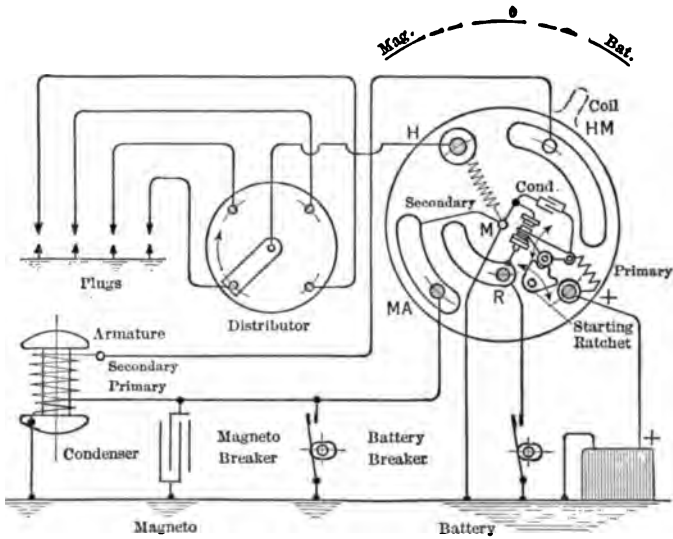

Eisemann H. T. Dual System. Battery Position.

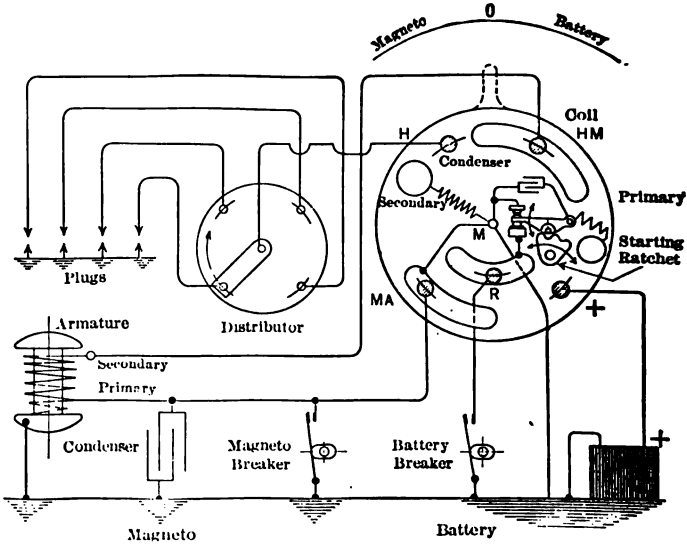

Eisemann H. T. Dual System. Off Position.

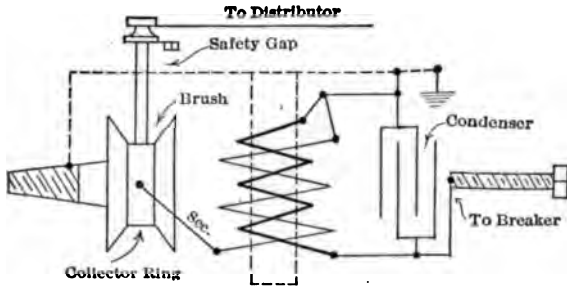

High-tension Magneto Armature.

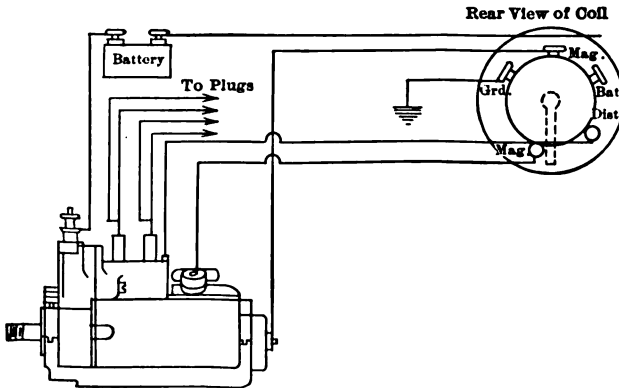

Mea Dual Magneto.

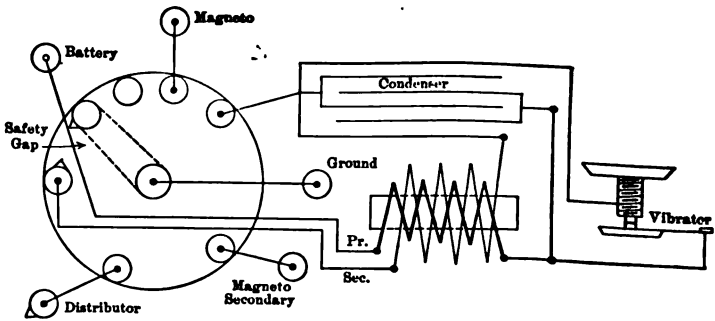

Magn Tube Coil.

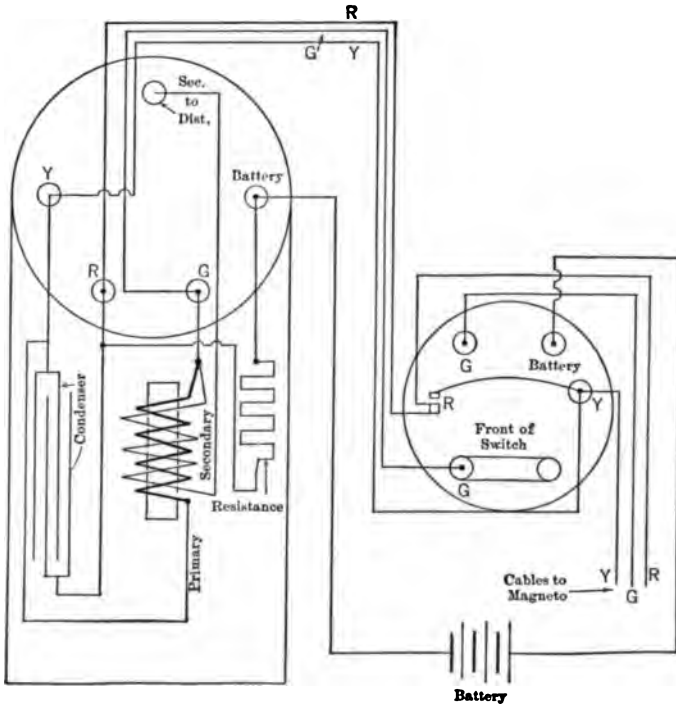

Remy RD Coil.

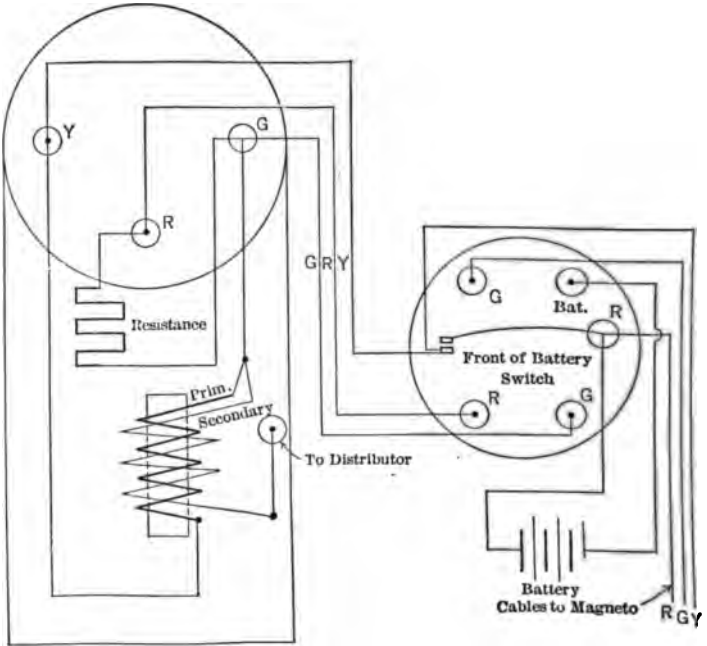

Remy LC Coil with D Switch.

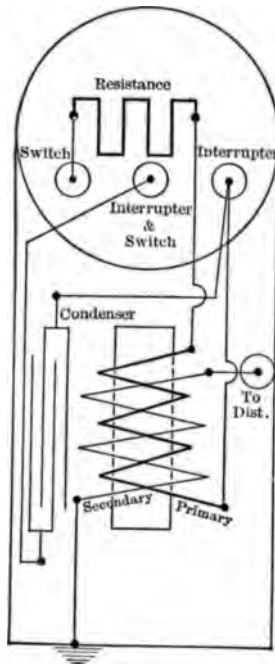

Remy Coil.

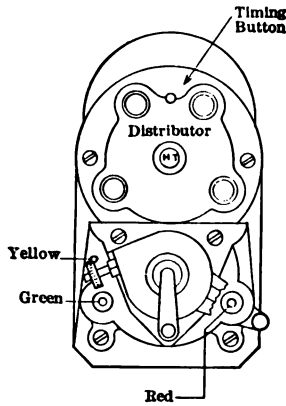

Remy Magneto. Models RL, RD and RF.

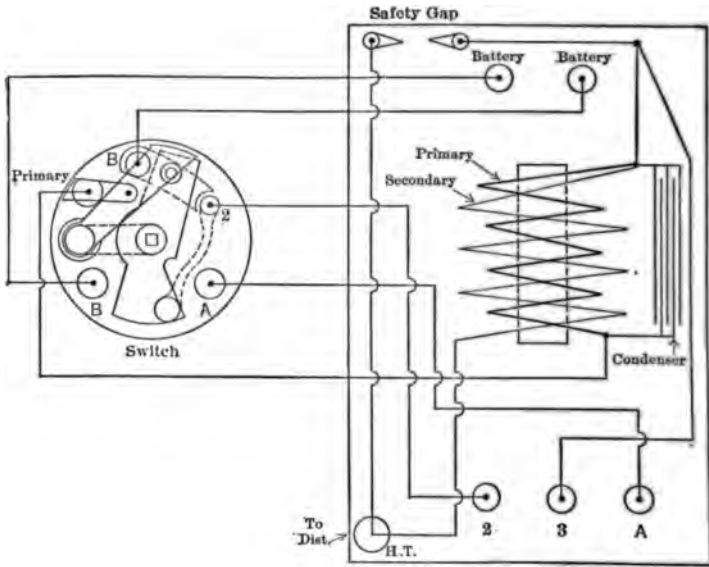

Splitdorf Box Coil.

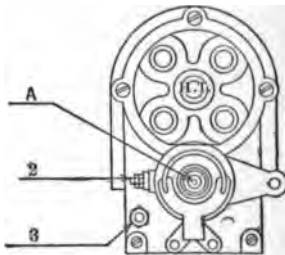

Splitdorf Magneto. Model A, B, C, D, F, H, O, S, SS and T.

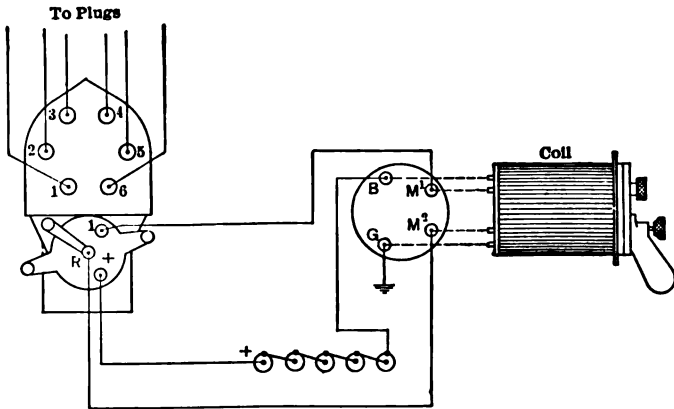

XIII Simms Magneto. SU 6-S. Clockwise System.

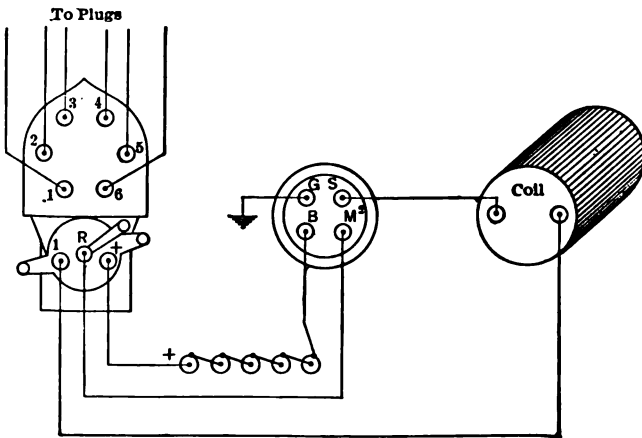

Simms Magneto. SU 6-D. Clockwise System.

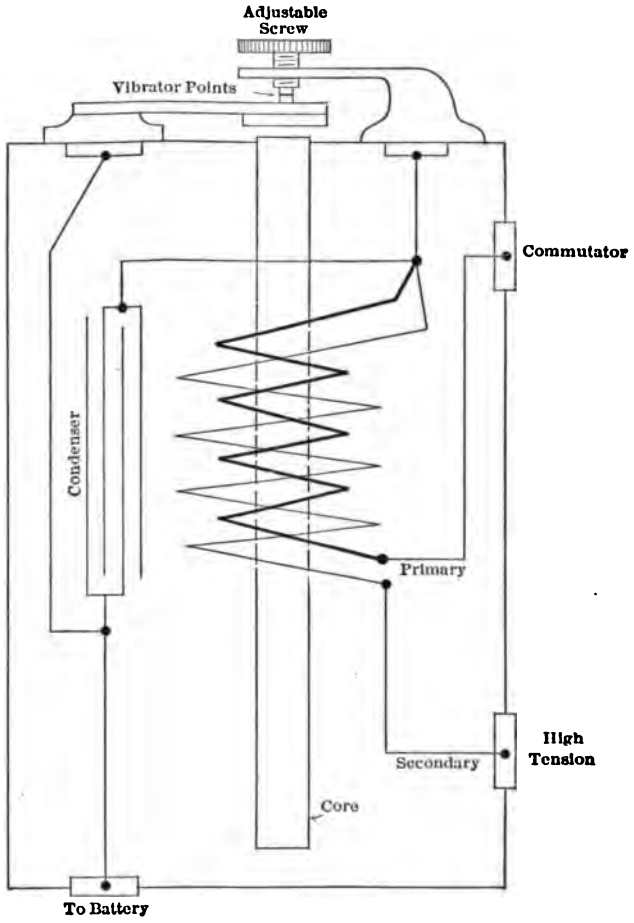

Vibrator Coil Unit.

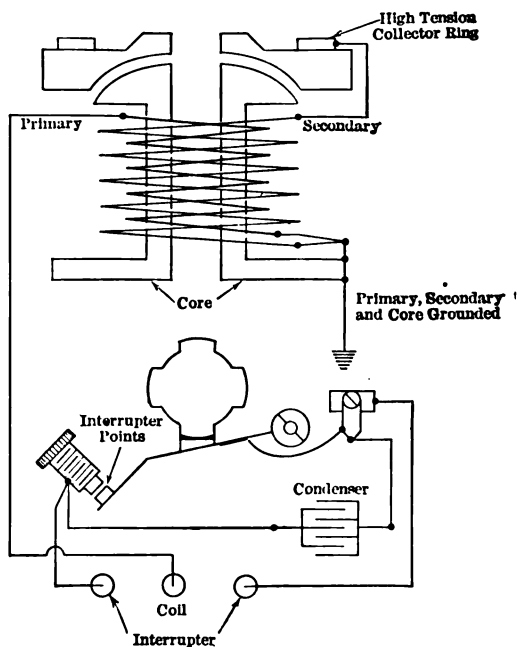

Westinghouse Vertical Ignition Unit. 4 and 6 Cylinders. Will operate R. H. or L. H. Rotation.

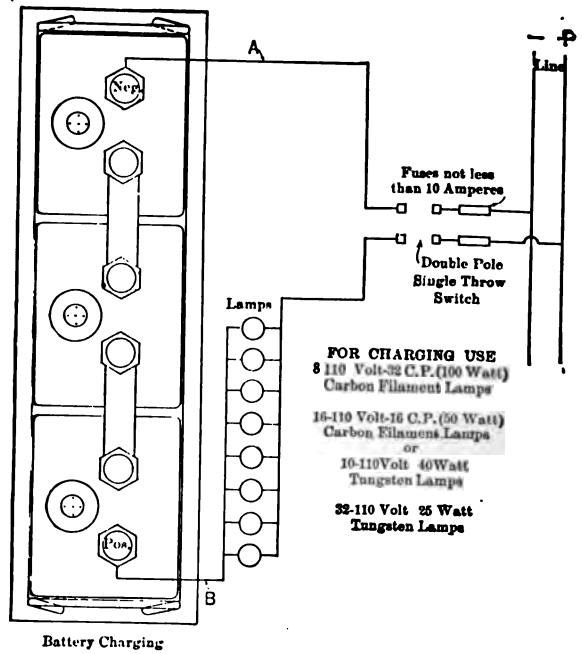
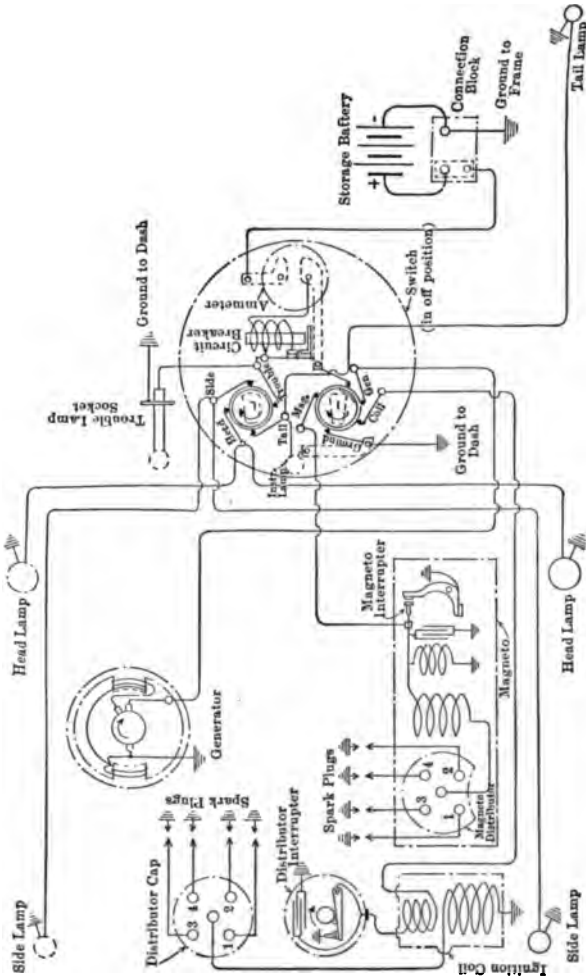
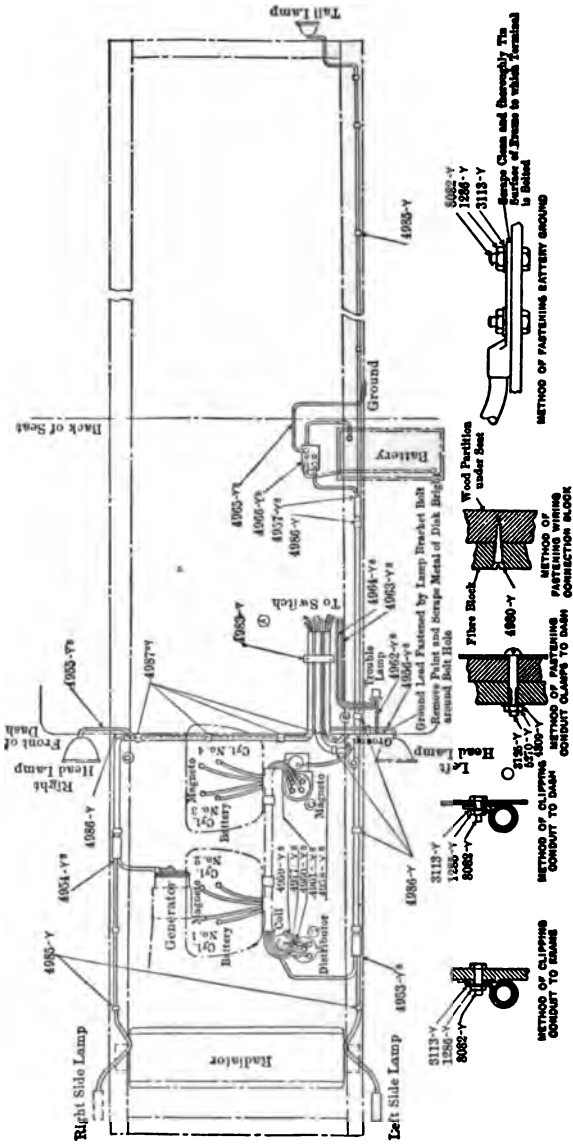

Diagram of Connections. For Charging One Type, "3 PH-Exide Battery from a 110-Volt D.C. Circuit.



U. S. A. Class B Truck. Wiring Diagram of Connections.



U. S. A. Class B Truck. Wiring Assembly.

INDEX

| | PAGE |
|--|-------|
| Allis-Chalmers Motor Generator..... | 118 |
| Allis-Chalmers Cutout and Regulator..... | 119 |
| Apelco Dynamo and Motor..... | 117 |
| Apelco Automatic Indicating Switch..... | 118 |
| Atwater-Kent Type "K-2" Ignition..... | 177 |
| Atwater-Kent Type "CC" Ignition..... | 178 |
| | |
| Battery charging from 110 volts D. C..... | 200 |
| Battery Ignition..... | 20 |
| Bijur Starting Motor..... | 119 |
| Bijur Motor Generator..... | 120 |
| Bijur Generator..... | 121 |
| Bijur Cutout..... | 121 |
| Bijur Packard System Generator..... | 122 |
| Bijur Cutout and Regulator for Packard System..... | 123 |
| Bijur Starting Motor for Packard System..... | 124 |
| Bosch Magneto Ignition, Cadillac 1911 Model..... | 130 |
| Bosch Magneto, DU 4, Dual System..... | 179 |
| Bosch Dual Coil, internal connections, external terminals..... | 179 |
| Bosch High Tension Magneto Armature with Collector Ring Distributor, internal diagram..... | 180 |
| Briggs-Stratton Dash Panel..... | 159 |
| Briggs-Stratton Cutout and Regulator..... | 159 |
| | |
| Coils—Induction (spark)..... | 16-22 |
| Commutators—Care of..... | 38-43 |
| Condensers..... | 8-10 |
| Connecticut Autolite..... | 140 |
| Connecticut Coil, internal connections, Type GO and GA..... | 180 |
| Connecticut Coil, Type GOM, internal connections..... | 181 |
| Connecticut Ignition Diagram..... | 140 |

| | PAGE |
|---|-------|
| Connecticut Ignition Wiring Diagram, Dort Model 5..... | 176 |
| Connecticut Type G Switch, internal connections..... | 181 |
| Cutout Relay—Principles of..... | 45-46 |
| Delco Coil, internal connections..... | 181 |
| Delco Coil, internal connections..... | 182 |
| Delco Coil, internal connections..... | 182 |
| Delco Coil, internal connections..... | 183 |
| Delco Dodge Ignition Circuit, internal diagram..... | 184 |
| Delco Ignition Unit for Dodge Car..... | 184 |
| Delco Generator for Cole 8-Cyl..... | 127 |
| Delco Generator for Oldsmobile, 8-Cyl..... | 128 |
| Delco Starting Motor for Oldsmobile 8-Cyl..... | 127 |
| Delco Wiring Diagram, Buick D4 Truck..... | 129 |
| Delco Wiring Diagram, Buick C54 and C55..... | 129 |
| Delco Wiring Diagram, Cadillac, 1911..... | 130 |
| Delco Wiring Diagram, Cadillac, 1914..... | 131 |
| Delco Wiring Diagram, Cadillac Type, 53..... | 132 |
| Delco Wiring Diagram, Cole Model 6-50..... | 133 |
| Delco Wiring Diagram, Cole Model 8-50..... | 134 |
| Delco Wiring Diagram, Oakland Model 38..... | 135 |
| Delco Wiring Diagram, Oakland Model 32B..... | 135 |
| Detroit Starter Co. Motor Generator..... | 126 |
| Disco Motor Generator..... | 124 |
| Disco Starting Motor..... | 126 |
| Disco Lighting Generator..... | 125 |
| Disco 6-Volt Cutout..... | 125 |
| Dodge Delco Ignition Circuit, internal diagram..... | 184 |
| Dry Cells—Construction—Use of..... | 11-12 |
| Dyneto Starting Motor..... | 136 |
| Dyneto Generator..... | 136 |
| Dyneto Wiring Diagram..... | 137 |
| Eisemann High-tension Dual, Pierce Ignition System, internal Magneto Position..... | 188 |
| Eisemann High-tension Dual, Pierce Ignition System, internal Battery Position..... | 189 |
| Eisemann High-tension Dual, Pierce Ignition System, internal Off Position..... | 190 |
| Eisemann D. C. Coil, internal connections, external terminals.... | 187 |

| | PAGE |
|--|---------|
| Eisemann Magneto, Type FM 4 Dual and D. C. Coil. | 186 |
| Eisemann Magneto: | |
| Explanation of circuits. | 30-32 |
| Diagrams. | 188-190 |
| Electricity—Principles of. | 5-8 |
| Electric Auto Lite Cutout. | 125 |
| Electric Auto Lite Wiring Diagram. | 140 |
| Electric Auto Lite Generator, Bucking Field or Reverse Series. | 138 |
| Electric Auto Lite Generator, Field Distortion Regulation. | 138 |
| Electric Auto Lite Starting Motor. | 139 |
| Electro-Magnetism. | 15-16 |
| Electrical Measurements. | 12-15 |
| Electric Motors—Theory of. | 43-45 |
| Entz Motor Generator. | 141 |

Firing Order and Timing of:

| | |
|-----------------------------|----|
| Abbott-Detroit. | 68 |
| Allen. | 68 |
| American. | 68 |
| Arbenz. | 68 |
| Auburn. | 69 |
| Buick. | 69 |
| Case. | 69 |
| Chalmers. | 69 |
| Chandler. | 69 |
| Cole. | 70 |
| Continental Motors. | 70 |
| Glide. | 70 |
| Grant. | 70 |
| Haynes. | 70 |
| Hudson. | 70 |
| Hupmobile. | 70 |
| Imperial. | 71 |
| Inter-State. | 71 |
| Jackson. | 71 |
| Jeffery. | 71 |
| Kuton. | 71 |
| King. | 71 |
| Knox. | 71 |
| Krit. | 72 |

| | PAGE |
|--|-------|
| Firing Order and Timing of: | |
| Lewis | 72 |
| Locomobile | 72 |
| Lozier | 72 |
| Lyons-Knight | 72 |
| Maxwell | 72 |
| Moline-Knight | 73 |
| Moon | 73 |
| National | 73 |
| Norwalk | 73 |
| Oldsmobile | 73 |
| Overland | 73 |
| Packard | 74 |
| Paige | 74 |
| Pierce-Arrow | 74 |
| Pilot | 74 |
| Pope-Hartford | 74 |
| Premier | 74 |
| Regal | 75 |
| Reo | 75 |
| Saxon | 75 |
| Simplex | 75 |
| Speedwell | 75 |
| Stearns-Knight | 75 |
| Stevens-Duryea | 76 |
| Studebaker | 76 |
| Velie | 76 |
| Winton | 76 |
| Focussing of Headlights | 116 |
| Generators | 34-35 |
| Generators—Regulation of output | 35-38 |
| Gray & Davis Starting Motor | 142 |
| Gray & Davis Generator | 143 |
| Gray & Davis Generator | 143 |
| Gray & Davis Cutout | 144 |
| Gray & Davis Generator | 144 |
| Gray & Davis Combined Regulator-Cutout | 145 |
| Gray & Davis Generator | 145 |
| Gray & Davis Motor Generator | 146 |

| | PAGE |
|---|-------|
| Gray & Davis Cutout and Regulator Combined..... | 147 |
| Gray & Davis Generator and Cutout..... | 147 |
| Gray & Davis Generator..... | 148 |
| Gray & Davis Technical Wiring Diagram, Grounded System..... | 148 |
| Gray & Davis Wiring Diagram, Two-Wire System..... | 149 |
| High-tension Magneto, internal connections..... | 186 |
| Ignition—Battery..... | 20-22 |
| Ignition—Magneto..... | 27-32 |
| Induction—Explanation of..... | 16-22 |
| Internal Diagram High-tension Magneto Armature..... | 191 |
| Leece-Neville Generator, Field Distortion Regulation..... | 149 |
| Leece-Neville Cutout..... | 150 |
| Leece-Neville Starting Motor..... | 150 |
| Lessons, Practical: | |
| Atwater-Kent..... Lesson No. 3..... | 78 |
| Atwater-Kent..... Lesson No. 4..... | 79 |
| Berling..... Lesson No. 21..... | 97 |
| Bosch..... Lesson No. 9..... | 82 |
| Bosch..... Lesson No. 10..... | 85 |
| Bosch..... Lesson No. 12..... | 86 |
| Bosch..... Lesson No. 16..... | 92 |
| Bosch..... Lesson No. 17..... | 93 |
| Bosch..... Lesson No. 20..... | 96 |
| Bosch Generator..... Lesson No. 28..... | 106 |
| Bosch Starter..... Lesson No. 29..... | 107 |
| Connecticut..... Lesson No. 23..... | 100 |
| Delco..... Lesson No. 15..... | 91 |
| Delco..... Lesson No. 24..... | 102 |
| Delco..... Lesson No. 25..... | 103 |
| Dixie Magneto..... Lesson No. 14..... | 88 |
| Eisemann Magneto..... Lesson No. 11..... | 86 |
| Ford Magneto..... Lesson No. 8..... | 82 |
| Leece-Neville..... Lesson No. 26..... | 104 |
| Leece-Neville..... Lesson No. 27..... | 105 |
| Low-tension Magneto..... Lesson No. 19..... | 95 |
| Remy Magneto..... Lesson No. 2..... | 78 |
| Remy Ignition..... Lesson No. 6..... | 80 |
| Remy Ignition..... Lesson No. 7..... | 81 |

| | PAGE |
|---|-------|
| Lessons, Practical: | |
| Remy Ignition..... Lesson No. 22..... | 99 |
| Simms Magneto..... Lesson No. 13..... | 87 |
| Splitdorf Magneto..... Lesson No. 1..... | 77 |
| "Standard" Magneto.. Lesson No. 18..... | 94 |
| Westinghouse Ignition.. Lesson No. 5..... | 80 |
| Low-tension Magneto, internal circuit..... | 186 |
| Magnetism..... | 1-5 |
| Magnetism—Attraction and Repulsion of Poles..... | 5 |
| Magneto Classification Definitions..... | 27-30 |
| Magneto Classification Outline..... | 27 |
| Magnetos—Internal Timing of "Shuttle Type"..... | 29-30 |
| Mea Dual Magneto Diagram..... | 191 |
| Mea Tube Coil, internal connections..... | 192 |
| North East Motor Generator with Regulator and Cutout..... | 151 |
| North East Motor Generator..... | 152 |
| North East Motor Generator with Master Relay..... | 152 |
| North East Starter Generator..... | 153 |
| North East Combined Cutout and Regulator..... | 153 |
| North East Wiring Diagram, Dodge Bros. Car..... | 154 |
| Remy Generator..... | 155 |
| Remy Combined Cutout and Regulator..... | 155 |
| Remy Starting Motor..... | 156 |
| Remy Wiring Diagram, Oakland Model 32..... | 157 |
| Remy-Wagner Wiring Diagram, Studebaker, 1916..... | 166 |
| Remy Ignition Coil, internal connections..... | 185 |
| Remy RD Coil and Switch, internal connections..... | 193 |
| Remy LC Coil with D Switch, internal connections..... | 194 |
| Remy Coil, internal connections..... | 195 |
| Remy Magneto, Models RL, RD and RF..... | 195 |
| Simms-Huff Lighting Generator and Starting Motor..... | 158 |
| Simms-Huff Dash Panel, Switch, Ammeter, Cutout and Regulator..... | 159 |
| Simms-Huff Combined Cutout and Regulator..... | 159 |
| Simms-Huff Regulator and Cutout..... | 160 |
| Simms SU 6-S Wiring Diagram..... | 197 |
| Simms SU 6-D Wiring Diagram..... | 197 |
| Soldering..... | 24-26 |

| | PAGE |
|---|--------------|
| Spark Advance and Retard: | |
| Automatic..... | 22 |
| Fixed..... | 22 |
| Hand..... | 22 |
| Semi-Automatic..... | 22 |
| Amount Allowable: | |
| See Timing..... | 23 |
| Splitdorf Box Coil and Switch, internal connections..... | 196 |
| Splitdorf Magneto, Models A, B, C, D, F, H, O, S, SS and T..... | 196 |
| Storage Batteries—Theory of..... | 46-51 |
| Storage Batteries—Care of..... | 51-56 |
| Storage Batteries—Work on..... | 57-58 |
| Tables—Handy..... | 111 |
| Tests—Preliminary Bench..... | 33-34 |
| Timing (sparks)..... | 23-24 |
| (Also see Firing Orders.) | |
| “ Trouble Shooting ”: | |
| Automatic Switch (Cut-out relay)..... | 63-65 |
| Auxiliary Circuits—Horn—Spot-light, etc..... | 65-68 |
| Batteries..... | 51-57 |
| Battery Ignition..... | 59-60 |
| Charging Circuit..... | 65 |
| Condensers..... | 33-34 |
| Field Circuits..... | 63 |
| High-tension Magnetos..... | 60-61 |
| Induction Coils..... | 33 |
| Lighting Circuits..... | 65-68 |
| Starting Circuits..... | 62 |
| U. S. A. Class B Truck, Wiring Diagram of connections..... | 201 |
| U. S. A. Class B Wire Assembly..... | 202 |
| U. S. L. Motor Generator..... | 161 |
| U. S. L. Motor Generator, 12-24 Volts..... | 162 |
| U. S. L. Cutout and Regulator..... | 160 also 163 |
| Vibrator Coil Unit, internal connections..... | 198 |
| Wagner D. C. Generator..... | 163 |
| Wagner Cutout..... | 164 |
| Wagner Cutout..... | 164 |
| Wagner Generator..... | 165 |

| | PAGE |
|---|------|
| Wagner Starting Motor..... | 165 |
| Wagner-Remy Wiring Diagram, Studebaker, 1916..... | 166 |
| Ward-Leonard Generator..... | 167 |
| Ward-Leonard Starting Motor..... | 167 |
| Ward-Leonard Combined Cutout Regulator..... | 168 |
| Ward-Leonard Combined Cutout Regulator..... | 168 |
| Ward-Leonard Car Wiring Diagram, Type E, Combined Cutout Regulator..... | 169 |
| Ward-Leonard Diagram with Type CC, Combined Cutout Regu- lator..... | 169 |
| Westinghouse Generator No. 400 Frame..... | 170 |
| Westinghouse Voltage Regulator and Cutout with No. 400 Frame Generator..... | 171 |
| Westinghouse Generator Frame No. 450..... | 172 |
| Westinghouse Cutout for Generator Frame No. 450..... | 173 |
| Westinghouse Starting Motor Frame No. 700..... | 173 |
| Westinghouse Motor Generator Frame No. 600..... | 174 |
| Westinghouse Third Brush Generator with Cutout Relay..... | 175 |
| Westinghouse Wiring Diagram, Dort Model 5..... | 176 |
| Westinghouse Vertical Ignition Unit, 4 and 6 Cyl. R. H. or L. H. Rotation..... | 199 |
| Wire-Copper Table..... | 108 |
| Wire-Iron Table..... | 109 |



0 013 398 621 2